



GST101

Conventional Fire Panel



Installation and Operation Manual

Issue 2.02 June 2012

ERP:30304838

CONTENTS

1 General	1
2 Technical specifications	1
3 Structure and Configuration	1
3.1 Appearance	1
3.2 Front Panel	2
3.3 Internal Structure	3
3.4 Terminals	3
3.5 Working Status	4
3.5.1 Zone Status	4
3.5.2 Output Status	4
3.5.3 Speaker.....	4
3.6 System Setting	4
3.6.1 Setting Operation Level.....	4
3.6.2 Setting Relay output	5
4 Mounting	6
5 Operation	6
5.1 Basic Operation	6
5.1.1 Silence of Fault and Fire Alarm	6
5.1.2 Self-test.....	7
5.1.3 Clearance of alarm state	7
5.1.4 Control of Sounders.....	7
5.2 Setting Delay State	8
5.3 Disabling the Zone	8
5.4 Setting Silence Delay	8
5.5 Setting Ground Fault	8
5.6 Wiring of Detectors, Manual Call Points and Output Loop	8
5.7 Typical Wiring Diagram	10
5.8 Calculation of Stand-by Battery Capacity	10
Appendix AEOL P-9907 Operation Instruction	11

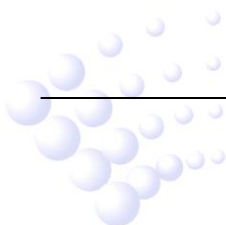

1 General

GST101 Conventional Fire Panel is developed using microprocessor. It can detect 1 zone, connecting with maximum 15 conventional detectors. It has 2 output control points to control some indicators, such as sounder strobes and sounders, etc. The panel is designed with stand-by batteries (two sealed acid storage batteries) and reserved space for installation; It is able to indicate normal status, fault, alarm and to check cables for short circuit or broken circuit. Installation and operation of the panel are very simple. All control functions are realized through a keyswitch.

2 Technical specifications

- ◇ Operating Voltage
24VDC 220VAC/230VAC 50Hz/60Hz
Recommended Wiring: 1.5mm² or above shield cable, complying with local installation codes.
- ◇ Stand-by Battery
The battery capacity can be calculated according to the equation in Section 5.8 of this manual. The maximum capacity is 4Ah (lasting for 24 hours in monitor state).
Recommended Wiring: Fire cable 2 core and Earth 1.5mm² CSA, complying with local installation codes.
- ◇ Detection Loop Parameters
Output voltage: 20VDC~28VDC
Standby current: 2.4mA (connecting with 15 conventional detectors)
Resistance in fire alarm condition: 150Ω ~1.5kΩ (normally 470Ω)
End of line resistance: 4.7kΩ or using active end of line unit(AEOL).
Recommended Wiring: Fire cable 2 core and Earth 1.0mm² CSA, complying with local installation codes.
- ◇ Output Parameters
Recommended Wiring: Fire cable 2 core and Earth 1.0mm² CSA, complying with local installation codes.
Sounder output: Output voltage 20VDC~28VDC, output current 1A, end of line resistance 4.7kΩ .
Fault output: Volt-free contact output, capacity 1A 24VDC
- ◇ Dimensions
210mm×297mm×90mm

3 Structure and Configuration

3.1 Appearance

Appearance of the panel is shown in Fig. 3.1.

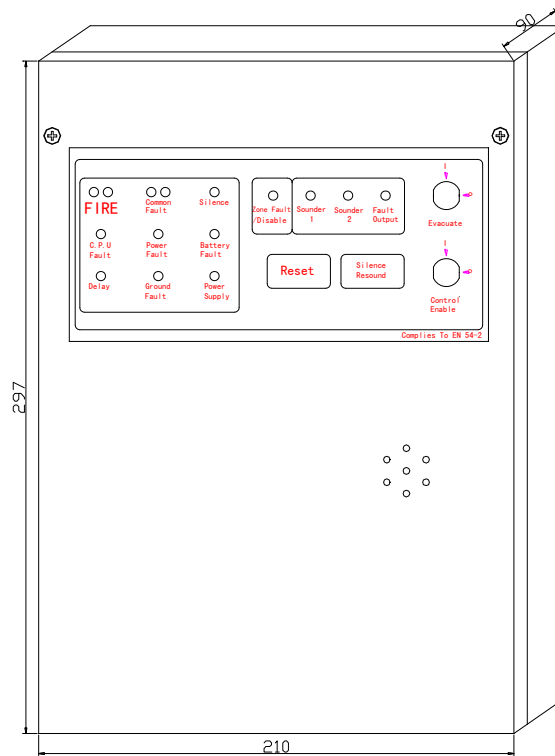

Fig. 3.1

3.2 Front Panel

Front panel of the panel is shown in Fig. 3.2.

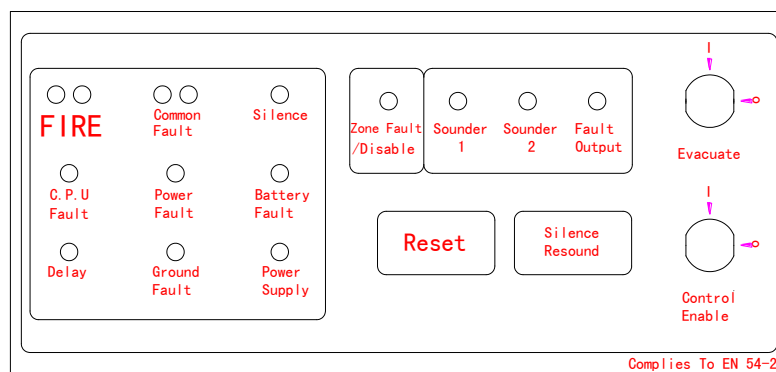

Fig. 3.2

Description of indicators and keys:

FIRE — Red, twin LEDs. They illuminate steadily when fire alarm occurs until the alarm is cleared.

Common Fault — Yellow, twin LEDs. They flash when any fault occurs.

Silence — Yellow. It illuminates steadily when the sounder is in silence state.

C.P.U Fault — Yellow. It illuminates steadily when the CPU is in fault.



- Power Fault** — Yellow. It illuminates steadily when AC power is in fault.
- Battery Fault** — Yellow. It illuminates steadily when the battery is in fault.
- Delay** — Yellow. It illuminates steadily when there is any output in delay state.
- Power Supply** — Green. It illuminates steadily when power supply is normal.
- Ground Fault** — Yellow. It illuminates steadily when there is ground fault.
- Zone Fault/Disable** — Yellow. It illuminates steadily when there is short circuit, broken circuit or there is removed detector.
- Sounder 1** — Yellow. It illuminates steadily when sounder 1 outputs, and flashes when it's in fault.
- Sounder 2** — Yellow. It illuminates steadily when sounder 2 outputs, and flashes when it's in fault.
- Fault Output** — Yellow. It illuminates steadily when fault output is activated.
- Reset key** — To reset or self-test.
- Silence/Resound key** — To silence internal speaker or to silence or resume sounder 1 and 2.

3.3 Internal Structure

Removing the two screws on top of the front panel, we can open the control panel and see its internal structure, as in Fig. 3.3.

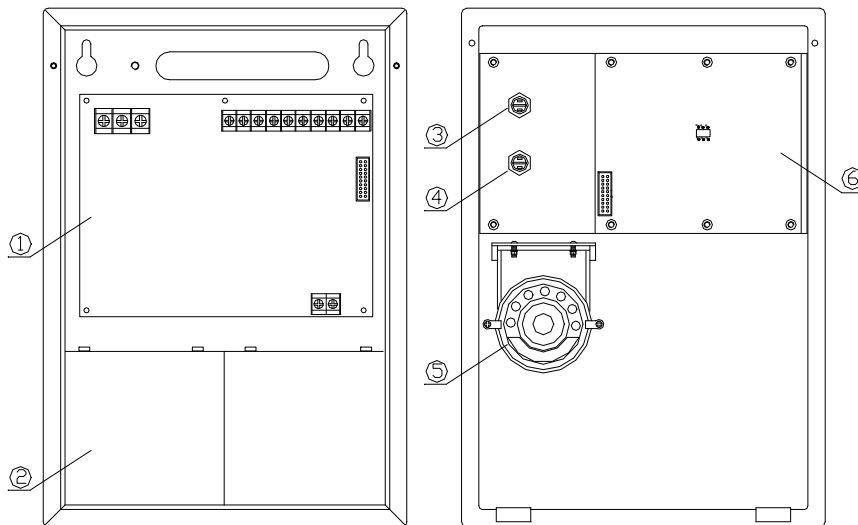
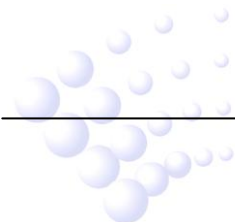

Fig. 3.3

- 1 Control Board 2 Battery 3 Evacuate Lock 4 Control Enable Lock
- 5 Speaker 6 Display Board

3.4 Terminals

Terminals are shown in Fig. 3.4.



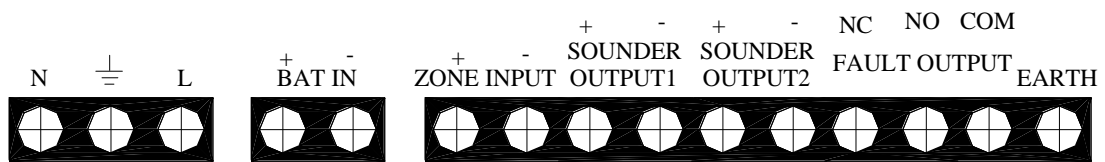

Fig. 3.4

N, \perp , L: 220VAC power terminals.

BAT IN (+, -): Battery terminals.

ZONE INPUT (+, -): Loop terminals.

SOUNDER OUTPUT1 (+, -): Sounder 1 output terminals.

SOUNDER OUTPUT2 (+, -): Sounder 2 output terminals.

FAULT OUTPUT (NC, NO, COM): Fault output terminals.

EARTH: To chassis earth.

3.5 Working Status

3.5.1 Zone Status

- ✧ Fault: The *Zone Fault/Disable* LED illuminates steadily and common fault LED flashes.
- ✧ Normal: The *Zone Fault/Disable* LED goes out.

3.5.2 Output Status

- ✧ Action: Corresponding output LED illuminates steadily.
- ✧ Fault: Corresponding output LED and *Common Fault* LED flash.
- ✧ Normal: All output LEDs turn off.

3.5.3 Speaker

- ✧ The speaker sounds according to sound priority. The 3 priority levels from high to low are: alarm, fault, normal.
- ✧ Alarm or manual start of sounder: 0.25s on, 0.25s off.
- ✧ Fault: 0.5s on, 4.5s off.
- ✧ Silence: 0.5s on, 9.5s off.

3.6 System Setting

3.6.1 Setting Operation Level

- ✧ As in Fig.3.6.1a, when “Control Enable” lock points to “O”, the panel is at level 1, and it can be silenced.
- ✧ As in Fig.3.6.1b, when “Control Enable” lock points to “I”, the panel is at level 2, the panel can self-test and reset, and sounders can be silenced.

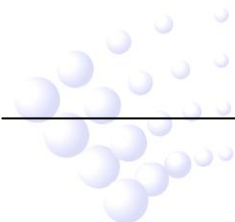

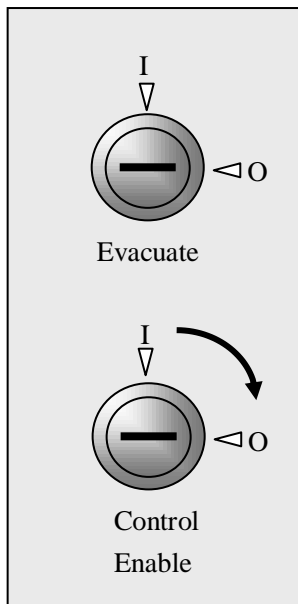

Fig. 3.6.1a

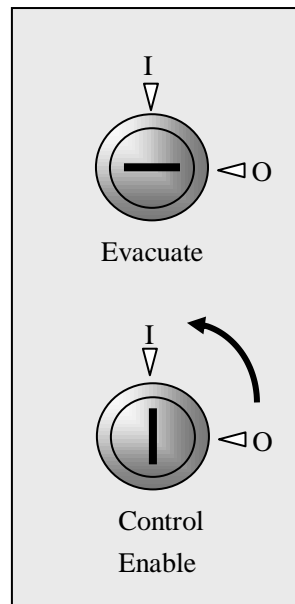

Fig. 3.6.1b

3.6.2 Setting Relay output

- 1 There are three output modes for the two sounders: normally closed contact output, normally open contact output and voltage output. For example: to set Sounder 1 as voltage output, plug fuse F2 and connect foot 5 with 6, and 2 with 3 of pin X2 by jumpers (location of the parts as in Fig.3.6.2).

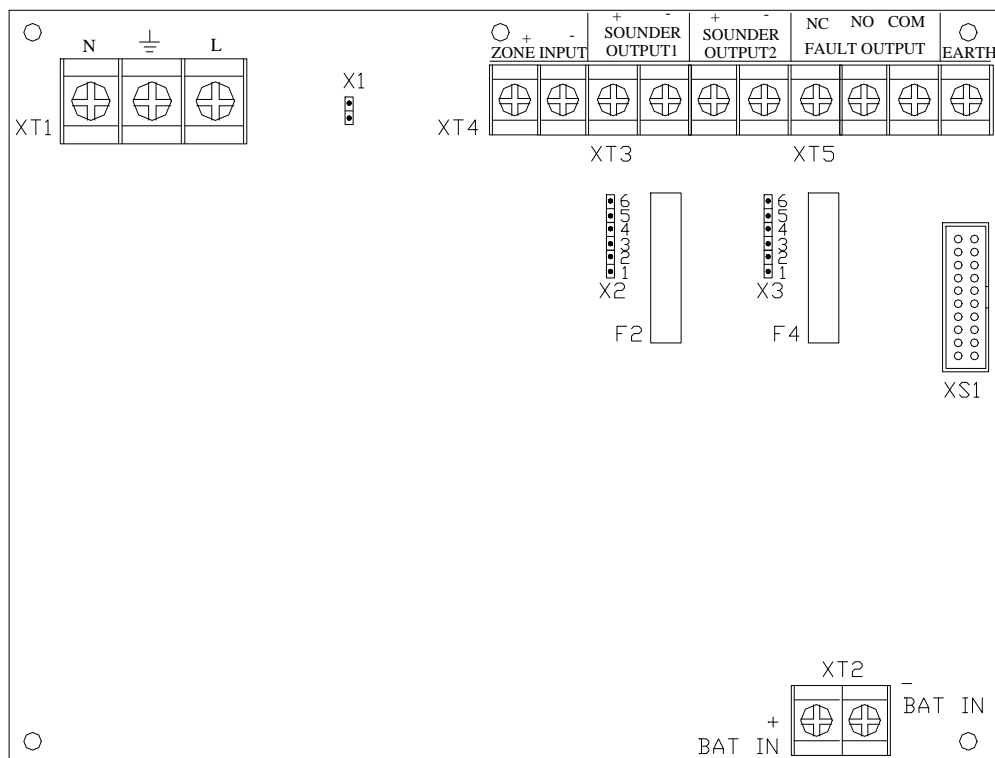

Fig. 3.6.2

- 2 Detailed configuration are shown in Table 1 (position of the parts is shown in Fig.3.6.2).

Table 1

Output	Normally closed contact		Normally open contact		Voltage output	
	Fuse to be removed	Jumpers	Fuse to be removed	Jumpers	Fuse to be removed	Jumpers
Sounder 1	F2	X2/ 3&4,1&2	F2	X2/ 5&4,1&2	/	X2/ 5&6,2&3
Sounder 2	F4	X3/ 3&4,1&2	F4	X3/ 5&4,1&2	/	X3/ 5&6,2&3

4 Mounting

The panel is walled-mounted, as shown in Fig. 4.1.

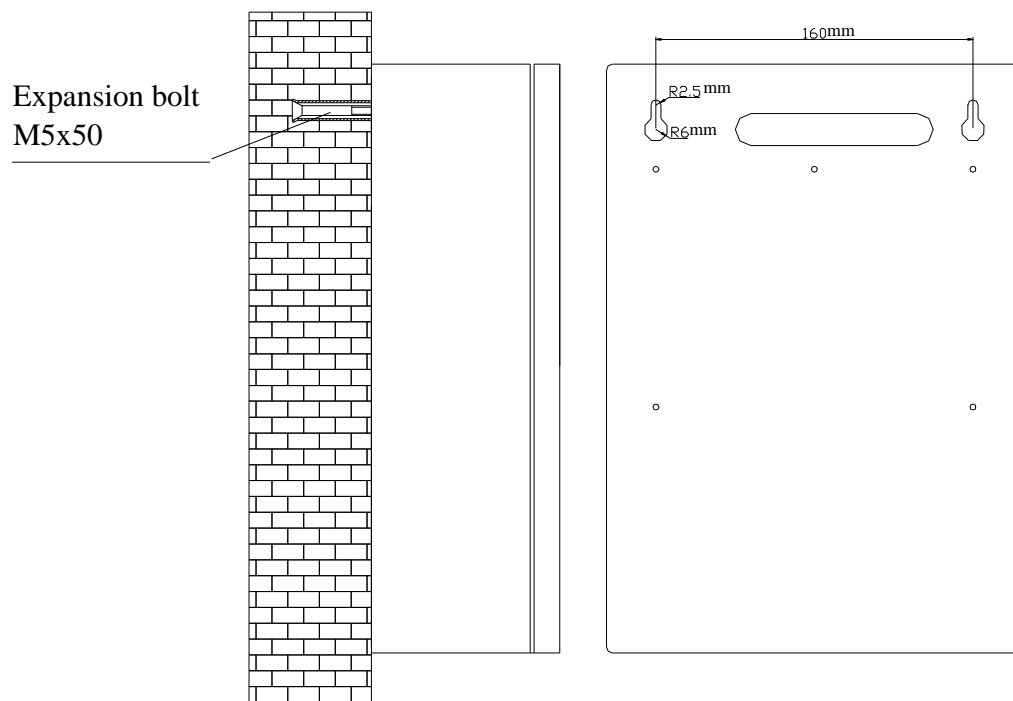

Fig. 4.1

5 Operation

5.1 Basic Operation

5.1.1 Silence of Fault and Fire Alarm

- ✧ When “Control Enable” lock points to “O”, the panel is in operation level 1; Pressing *Silence/Resound*, the speaker of the panel can be silenced.
- ✧ When “Control Enable” lock points to “I”, the panel is in operation level 2; Pressing *Silence/Resound*, *Silence* LED illuminates, the sounders are silenced and the panel’s speaker is also silenced. Pressing *Silence/Resound* again, the sounders will sound again and *Silence* LED goes out.

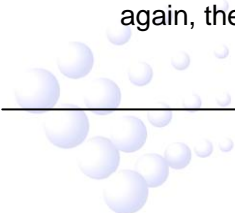

5.1.2 Self-test

In monitoring state, the panel is in operation level 2. Pressing and holding *Reset* for 1 second, it will self-test the sound and LEDs.

5.1.3 Clearance of alarm state

Clearance of fault and fire alarm is under operation level 2. Pressing and holding *Reset* for 1 second in fire alarm state, we can clear the fire alarm and all outputs.

5.1.4 Control of Sounders

- 1 As in Fig.5.1.4.1, when “Evacuate” lock points to “I”, the two sounders will be activated.

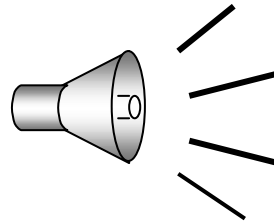
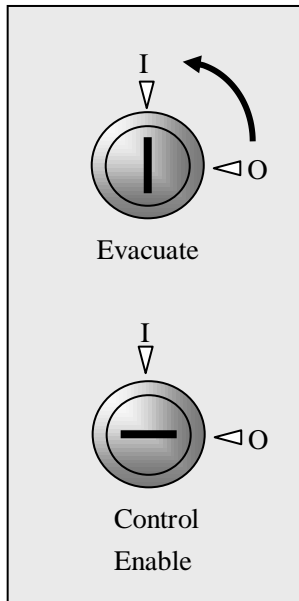

Fig. 5.1.4.1

- 2 As in Fig.5.1.4.2, when “Evacuate” lock points to “O”, the sounders will be stopped.

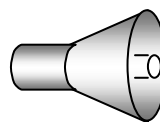
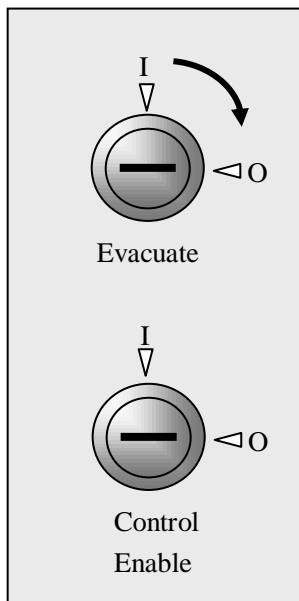
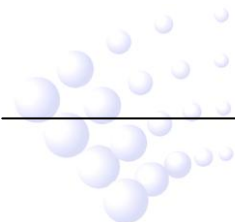

Fig. 5.1.4.2



5.2 Setting Delay State

- 1 Sounder 1, sounder 2 and fault output can be set to delay or immediate output through jumpers on the display board.
- 2 Delay time can be set as 30 seconds or 5 minutes.
- 3 Setting pins of delay time are shown in Fig. 5.2.

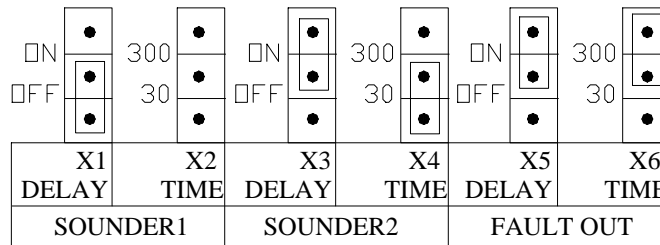

Fig. 5.2

In Fig. 5.2, Sounder 1 is in immediate output state; Sounder 2 is delayed for 30 seconds; Fault output is delayed for 5 minutes.

5.3 Disabling the Zone

The toggle switch SW1 on the display board can be used for setting disable status of the zone. Toggling DIP1 to ON, the zone is disabled, and the *Zone Fault/Disable* LED illuminates.

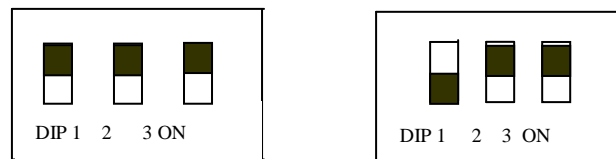

Fig. 5.3

5.4 Setting Silence Delay

Toggle switch SW1 on the display board can also be used for setting the delay silence mode. Turning DIP2 of SW1 to ON can set the panel at delay silence mode. In this mode, the delay silence can be allowed or forbidden. If the delay silence is allowed, the sound can't be silenced until a fire alarm lasts for more than 3 minutes or there at least exists 2 fire alarms. The *Reset* key should be operated only when the control panel is in the state of silencing.

5.5 Setting Ground Fault

Shorting pin X1 with a jumper will enable the panel to check ground fault. Otherwise it doesn't check ground fault.

5.6 Wiring of Detectors, Manual Call Points and Output Loop

- 1 Considering electromagnetic compatibility, shielded cables should be used. Please keep the shield layer reliably contacted with the chassis.
- 2 There can be 15 detectors and unlimited number of manual call points in the loop, and there are two wiring methods.

- (1) Connect all manual call points in front of the detectors and a 4.7kΩ resistor at the end of the loop (Fig.5.6.2a).

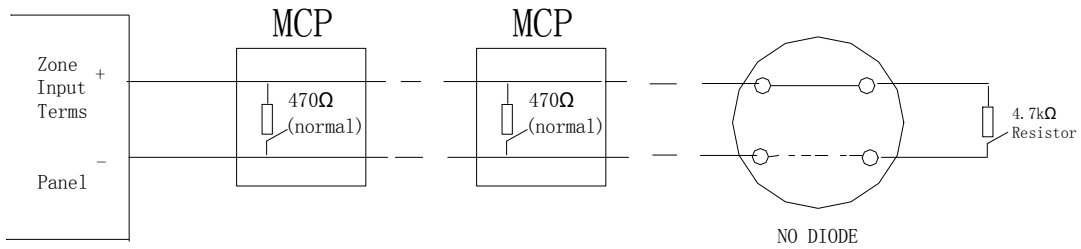

Fig.5.6.2a

- (2) Connect the detectors and manual call points at any position and an Active End of Line Unit (AEOL) at the end of the loop. A diode should be connected on the detector base (Fig.5.6.2b).

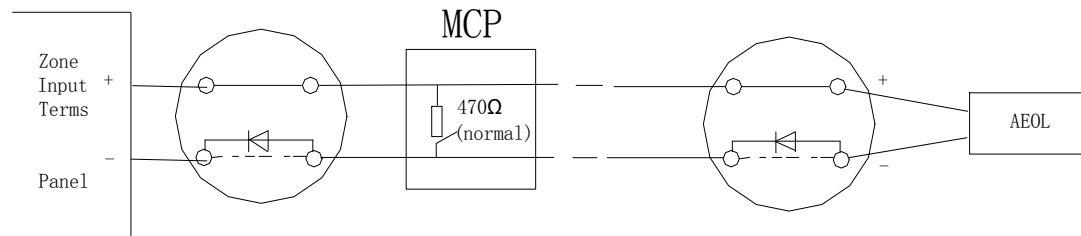
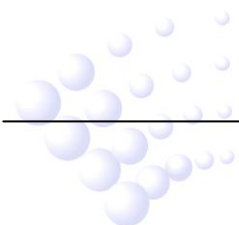

Fig.5.6.2b

- 3 Wiring of Output Loop: The sounders and remote devices should be polarity-sensitive and connected into the loop according to the marked polarity. A 4.7kΩ resistor should be paralleled at end of the loop.



5.7 Typical Wiring Diagram

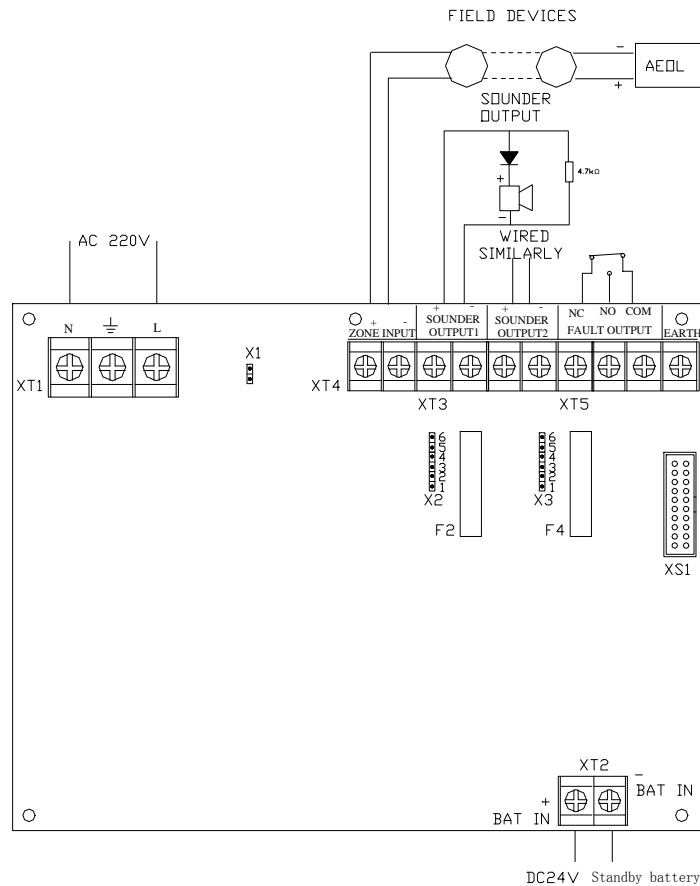

Fig.5.7

5.8 Calculation of Stand-by Battery Capacity

- 1 Battery voltage: 24VDC
- 2 Power supply specifications

The equation for calculating the battery capacity is as follows:

$$\text{Battery Capacity (Ah)} = K \times [I1 \times T1 + (I2 + I3) \times T2] \text{Ah}$$

In which,

I1 is the current consumption of the panel when the battery works in normal standby condition, which is 0.1A.

I2 is the current consumption of the panel when the battery works in alarm condition, which is 0.25A.

I3 is the output current when the battery works in alarm condition, which is 1A.

T1 is the time for the battery to work in monitoring status which shall be 24 hours by EN 54 standard.

T2 is the time for the battery to work in alarm condition which shall be 0.5 hour by EN 54 standard.

K is a margin factor, which is recommended by the manufacturer to be 1.25.

Appendix AEOL P-9907 Operation Instruction

1 Technical Specifications

- 1) Technical Specifications:
 - Range of Operating Voltage: 15VDC~28VDC
 - Rating Voltage: 24VDC
 - Equivalent Resistor: 4.7k Ω
 - Operating Current \leq 5mA
- 2) Operating Environment:
 - Temperature: -10 $^{\circ}$ C~+50 $^{\circ}$ C
 - Relative Humidity <95% (40 $^{\circ}$ C \pm 2 $^{\circ}$ C)

2 Structure

- 1) View from the bottom is shown in Fig. A-1.

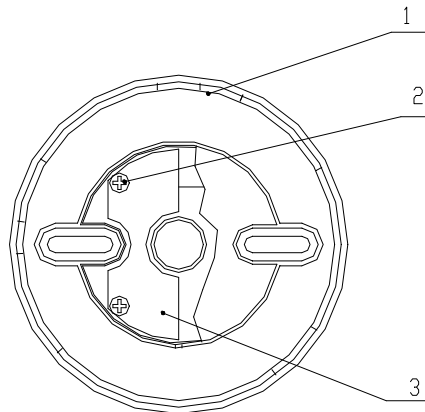

Fig. A-1

1. Enclosure
2. Fixing Screw
3. Circuit Board

- 2) View from the top (without cover) is shown in Fig. A-2.

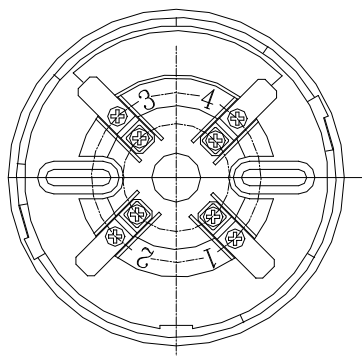
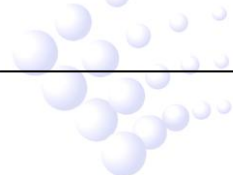

Fig. A-2

3 Mounting and Wiring

- 1) Wiring is as follows:



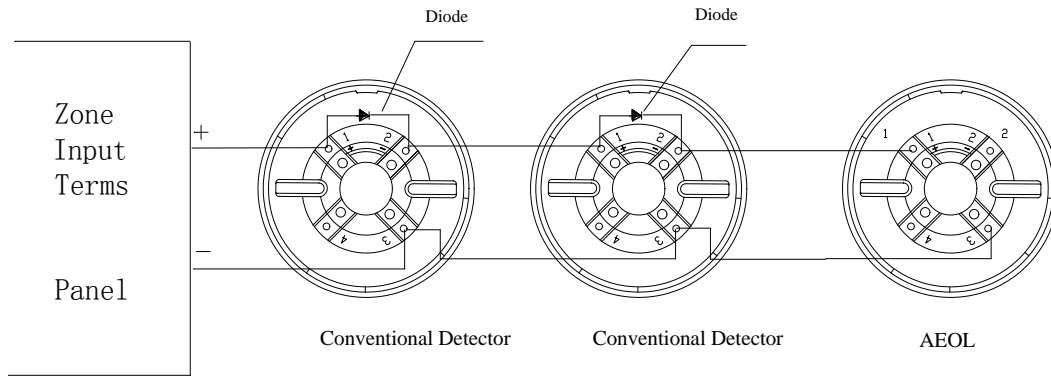

Fig. A-3

2) Mounting and Wiring

The installation of AEOL is the same as fire alarm detector base. But there are two wiring methods:

- a) The AEOL can be used as a detector base to install a conventional detector on it. In this way, connect the anode of the zone bus to terminal "1" and the cathode of the zone bus to terminal "3".
- b) If the AEOL is not installed with detectors, then connect the anode of zone bus to terminal "2" and the cathode of the zone bus to terminal "3".

3) Cautions

- a) The polarity of zone bus should not be reverse.
- b) When the detector is removed, make sure the diode be in sequence in the circuit.

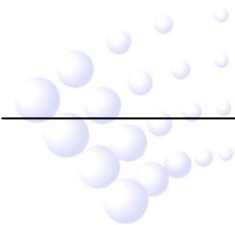



Gulf Security Technology Co., Ltd.

No. 80, Changjiang East Road, QETDZ, Qinhuangdao, Hebei,

P. R. China 066004

Tel: +86 (0) 335 8502434

Fax: +86 (0) 335 8502532

service.gst@fs.utc.com

www.gst.com.cn