



GST102A/104A/108A/116A Conventional Fire Alarm Control Panel



Installation and Operation Manual

Issue 1.06

ERP:30311272



QUICK OPERATION GUIDE	
PANEL FAULT BUZZER:	Press the “SILENCE BUZZER” button to silence the panel fault buzzer.
For any of the below functions you must be in Access Level 2 mode	
ACCESS LEVEL 2 MODE:	Insert the 003 key and turn to the “ON” position.
PANEL ALARM BUZZER:	Press the “SILENCE BUZZER” button to silence the panel alarm buzzer.
WARNING SYSTEM ACTIVATION:	Press the “EVAC” button for manual activation of the warning system. Alternatively, if an alarm has been activated press the “SILENCE/RESOUND ALARM” button to silence and reactivate the warning system.
FIRE MODE DISABLING:	To disable zones in fire mode, press “SILENCE/RESOUND ALARM” then “DISABLE” to disable all zones that have been activated in fire mode.
DISABLING ZONES:	<p>Press the “DISABLE/ENABLE” button.</p> <p>Use the “SCROLL” button to cycle through to the desired zone or sounder output.</p> <p>Press the “ENTER” button to save, Panel buzzer will sound for 1s to indicate successful setup.</p> <p>Press the “SCROLL” button to continue to addition zones/sounder outputs.</p> <p>Press the “CANCEL” or “DISABLE/ENABLE” to exit this menu.</p>
DISABLING WARNING SYSTEM:	Press the “DIS/ENABLE WARNING SYSTEM” button.
ENABLEMENT:	Repeat the disablement procedure above.
PANEL RESET:	Press the “RESET” button.
EXIT:	Turn the 003 key to the “OFF” position and remove key.

CONTENTS

Installation Precautions	1
EN 54 Information.....	2
Chapter 1 Product Overview	3
1.1 Features	3
1.2 Technical Specifications	3
1.2.1 Operating Voltage	3
1.2.2 Batteries	4
1.2.3 Load of Power Supply	4
1.2.4 Detection Zone	4
1.2.5 Output Interface	4
1.2.6 Input Interface	5
1.2.7 Installation and Storage	6
1.3 Controls and Indications	6
1.3.1 Common Status Indicators.....	6
1.3.2 Zone Status Indicators	7
1.3.3 Operating Indicators and Keys	7
1.4 Configuration and Functions.....	8
1.4.1 Internal Components.....	8
1.4.2 Configuration and Functions of GST-116A	8
1.4.3 Configuration and Functions of GST-108A.....	9
1.4.4 Configuration and Functions of GST-104A.....	9
1.4.5 Configuration and Functions of GST-102A.....	9
1.5 Terminal Description	9
1.5.1 Terminals on the Control Board	9
1.5.2 Terminals on Extension Board	10
1.5.3 Terminals on Relay Board of RB116A	11
1.5.4 Terminals on Relay Board of RB108A	11
1.6 Appearance and Dimensions.....	13
Chapter 2 Installation and Wiring	14
2.1 Installing the Cabinet	14
2.2 Mains Connection	16
2.3 Battery Connection	16

2.4 Zone Input Connection	17
2.4.1 Using end of line resistor	17
2.4.2 Using an Active End of Line Unit	17
2.5 Sounder/Fire Alarm Output Connections.....	17
Chapter 3 System Setup	18
3.1 Setting Access Levels.....	18
3.1.1 Setting Access Level I.....	18
3.1.2 Setting Access Level II.....	18
3.1.3 Setting Access Level III.....	18
3.2 Setup of the Sounder / Alarm Output	18
3.3 Disablement of a Zone or Output	19
3.3.1 Use of Disablement Function.....	19
3.3.2 Operation Basic Steps – Generally used for individually Disabling Zones or Sounder /Alarm Outputs when the panel is in normal operation mode.....	20
3.3.3 Quick Disablement Function – Generally used for group Disablements of Zones or Sounder Outputs when the panel is in Alarm mode.	20
3.4 Setting Test Mode	21
3.4.1 Use of Test Mode	21
3.4.2 Operation Steps	21
3.4.3 Test zone output mode.....	22
3.5 Programming Output Modes	22
3.5.1 Setting Zone “With Manual Call Point”.....	22
3.5.2 Setting Associated Sounders to a Zone	23
3.5.3 Setting Delay Time of Alarm Output.....	24
3.5.4 Sounder Output Mode.....	24
3.6 Supervisory Mode	26
3.6.1 Use of Supervisory Function.....	26
3.6.2 Programming a Zone to Supervisory	26
3.7 Setting Auxiliary Functions	27
3.8 Ground Fault Detection.....	27
3.9 Auxiliary Power Setting	27
3.10 Restore Default Settings.....	28
Chapter 4 Operation Instructions	29
4.1 Working State Description	29

4.1.1 State of Detection Zones	29
4.1.2 Alarm Output State	29
4.1.3 Sounder Outputs State	29
4.1.4 Safe State	29
4.1.5 Description of the Buzzer	30
4.1.6 Others.....	30
4.2 Acknowledgement and Silence of Fault	31
4.3 Acknowledgement and Silence of Fire Alarm	31
4.4 Silencing the Sounder Outputs	31
4.5 Evacuation	31
4.6 Self-test and Reset	31
Chapter 5 Calculation of Batteries Capacity	32
Chapter 6 Servicing.....	33
6.1 Replacing the Batteries.....	33
6.2 Replacing the Fuses	33
6.2.1 Follow the Steps Below to Replace F1	33
6.2.2 Follow the Steps Below to Replace 5A Fuse.....	33
6.3 Troubleshooting	34
Compliance information.....	35
WEEE Information.....	36
Limited Warranty	37
Product warnings and disclaimers	37

Installation Precautions

Adherence to the following will aid in problem-free installation with long-term reliability:

- ✧ Do not attempt to install, service, or operate this unit until this manual is read and understood.
- ✧ This equipment must be installed in accordance with these instructions and the appropriate national, regional and local regulations specific to the country and location of the installation. Consult with the appropriate authority having jurisdiction for confirmation of the requirements.
- ✧ The CIE shall only be installed and serviced by specially trained fire alarm system technicians.
- ✧ Disconnect all sources of power before servicing. The CIE may be damaged by removing and/or inserting cards, modules, or interconnecting cables while the unit is energized.
- ✧ Remove all electronic assemblies prior to any drilling, filing, reaming, or punching of the enclosure. When possible, make all cable entries from the sides or rear. Before making modifications, verify that they will not interfere with batteries and printed circuit board location.

EN 54 Information

EN 54
✓

GST102A/104A/108A/116A Conventional Fire Alarm Control Panel (FACP) complies with the requirements of EN 54-2 1997 + A1: 2006 and EN 54-4 1997+A1: 2002+A2:2006. In addition to the basic requirements of these standards, the panel conforms to the following optional requirements.

Option		EN 54-2 Clause
Control	Delays to outputs	7.11
	Test condition	10
Outputs	Output to fire alarm devices	7.8
	Output to fire alarm routing equipment	7.9.1

EN 54
✓

The power supply of GST102A/104A/108A/116A complies with the following EN 54-4 requirements.

Power Supply Functions	EN 54-4 Clause
Power supply from the main power source	5.1
Power supply from the standby power source (batteries)	5.2
Charger	5.3
Faults	5.4

EN 54
✓

CPD Conformity Information

 2831
Gulf Security Technology Co., Ltd. No. 80, Changjiang East Road, QETDZ, Qinhuangdao, Hebei, P. R. China 066004 11 GST102A 2831-CPR-F4050 GST104A 2831-CPR-F4051 GST108A 2831-CPR-F4049 GST116A 2831-CPR-F4052
EN 54-2 1997 + A1: 2006 EN 54-4 1997 + A1: 2002 + A2: 2006 Control and indicating equipment for fire detection and fire alarm systems for buildings Provided Options: Delays to outputs Test condition Output to fire alarm devices Output to fire alarm routing equipment Please refer to this manual for other technical data.

Chapter 1 Product Overview

GST102A/104A/108A/116A Conventional Fire Alarm Control Panel is designed in compliance with EN 54-2. It's compatible with GST C-9403 Conventional Sounder Strobe designed by EN 54-3, C-9103 Conventional Rate of Rise and Fixed Temperature Heat Detector by EN 54-5, C-9102 Conventional Photoelectric Smoke Detector by EN 54-7, and DC-9204 Conventional Manual Call Point by EN 54-11. The panel is easy to install and operate. Control functions are enabled by a key switch. Programming functions are enabled by a key switch and an internal switch.

This series of panels are basically the same in application and operation, their only main differences being the amount of zones and the size of the cabinets, see table 1-1.

Table 1-1

FACP	Number of Detection Zones	Number of Sounder Outputs
GST102A	2	3
GST104A	4	3
GST108A	8	3
GST116A	16	3

1.1 Features

- ◇ Supports up to 16 detection zones, with conventional detectors and manual call points; the maximum number of external conventional points per zone is 32.
- ◇ Three sounder outputs, one alarm output, one fault output and one disable/supervisory output.
- ◇ Able to report short and open circuits of zones, sounder outputs and alarm output.
- ◇ Test and disable functions
- ◇ Programmable on manual call point connection, sound modes, sounder delay modes and output delay modes.
- ◇ Three access levels settable via the key switch and the internal switch.
- ◇ Reserved repeater panel interface for fire alarm indication of multiple zones.
- ◇ Designed with standby batteries and space provision for two sealed lead-acid batteries.
- ◇ The maximum number of points per CIE as shown in Table 1-2.

FACP	GST102A	GST104A	GST108A	GST116A
Max points	≤64	≤128	≤256	<512

1.2 Technical Specifications

1.2.1 Operating Voltage

- ◇ Input Voltage: 220V/230VAC^{+10%}_{-15%}
- ◇ Frequency: 50/60Hz
- ◇ Input Current: 0.8 A
- ◇ Fuse: 250VAC, T2A in SPS
- ◇ Recommended Wiring: 1.5mm² or above of shield cable, complying with local installation code.

☆☆

Note: External overcurrent protection device is required and should be installed near the equipment.

☆☆

1.2.2 Batteries

- ◇ Minimum Operating Voltage: 21.5V
- ◇ Maximum Charging Current: 400mA
- ◇ Maximum Charging Voltage: 27.6V
- ◇ Battery Type: Sealed lead-acid battery
- ◇ Minimum Batteries: 2 batteries, 7Ah/12VDC
- ◇ Recommended Battery and Model: Yuasa NP7-12
- ◇ Standby battery maximum operating current: 2.5A
- ◇ Standby battery current with full-loaded: 0.1A
- ◇ Maximum Internal Resistance: 1.0 Ω

1.2.3 Load of Power Supply

- ◇ The maximum output current in standby condition is 550mA (Max. a as described in Table 1 of EN 54-4 Clause 9.2.1.)
- ◇ The maximum output current in alarm condition is 2.35A (Max. b as described in Table 1 of EN 54-4 Clause 9.2.1).
- ◇ The Minimum output current in fully charged condition is show in Table1-3 (I Min. as described in Table 1 of WN54-4 Clause, 9.2.1)

Table 1-3

FACP	GST102A	GST104A	GST108A	GST116A
I min(mA)	40	50	70	110

1.2.4 Detection Zone

The control panel supports up to 16 detection zones, and the number of external conventional detectors in each zone reaches 32, with the following parameters:

- ◇ Loop Voltage: 15VDC~28VDC
- ◇ Maximum output current per zone: 170mA.
- ◇ Dynamic Current: Resistance range for fire alarm is 150 Ω ~1.5k Ω (normally 470 Ω), using a 4.7k Ω end of line resistor or AEOL (active end of line unit). The alarm current for a zone depends on the number of conventional devices in the zone. The alarm current for a conventional detector is about 25mA.
- ◇ Maximum output current for the 16 detection zones is 400mA.
- ◇ Recommended Wiring: 1.0mm² or above 2 core cable, complying with local installation codes.
- ◇ Recommended Cable Length: no more than 1000m

1.2.5 Output Interface

- ◇ Fault Output
 - Type: normally open/close contact output

- Contact capacity: 1A/24VDC
- ✧ Disable/Supervisory Output (defaulted disable output)
 - Type: normally open/close contact output
 - Contact capacity: 1A/24VDC
- ✧ Alarm output
 - Type: voltage contact output, normally open/close contact output are available, (defaulted normally open contact output)
 - Contact capacity: 1A/24VDC
 - Output voltage: 18VDC~28VDC
 - Output current: 300mA in alarm
 - End-of-line-resistor: 4.7kΩ
- ✧ Sounder output 1
 - Type: voltage contact output, normally open/close contact output (defaulted voltage contact output)
 - Contact capacity: 1A/24VDC
 - Output voltage: 18VDC~28VDC
 - Output current: 300mA in alarm
 - End-of-line-resistor: 4.7kΩ
- ✧ Sounder 2/3 output
 - Type: voltage contact output
 - Output voltage: 18VDC~28VDC
 - Output current: 300mA in alarm
 - End-of-line-resistor: 4.7kΩ
- ✧ Auxiliary Power Output
 - Output Voltage: 18VDC~28VDC
 - Output current: 450mA in standby mode and Maximum 1000mA in alarm mode when the Alarm Output has been set to a normally open/close contact type. (Refer 3.2)
- ✧ Repeater output
 - Type: open-collector output
 - Output Voltage: 18VDC~28VDC
- ✧ Recommended Wiring: 1.0mm² or above 2-core cable, complying with local installation codes. Please refer to repeater panel instruction manual for installation and wiring requirements.
- ✧ Recommended Cable Length: no longer than 1000m

1.2.6 Input Interface

- ✧ RESET/EVAC/SILENCE input
 - Type: normally open contact input
- ✧ Recommended Wiring: 1.0mm² or above 2-core cable, complying with local installation codes.
- ✧ Recommended Cable Length: no longer than 1000m

1.2.7 Installation and Storage

The control panel is applicable for indoor use below the elevation of 2000m. Overvoltage level is Class II and pollution degree is 2. Ingress protection level is IP30.

- ✧ Installation Environment
 - Temperature: 0°C~40°C
 - Relative humidity ≤95%, non-condensing
- ✧ Storage Environment:
 - Temperature: -5°C~50°C
 - Relative humidity ≤95%, non-condensing

1.3 Controls and Indications

The fascia of the GST-116A is shown below in Fig. 1-1.

There is no Control Enable 003 key-switch used on the large cabinet version panels as Access Level 2 is achieved when opening the front door (with glass window) which has a 003 lock.



Fig. 1-1

1.3.1 Common Status Indicators

- ✧ **FIRE:** Red. It flashes when there is fire alarm and illuminates steadily when the fire sound is silenced.
- ✧ **ALARM ROUTING ACTIVATED:** Red. It illuminates steadily when the alarm output is activated.
- ✧ **POWER:** Green. It illuminates steadily when the CIE is powered up.
- ✧ **FAULT:** Yellow. It flashes when there is a fault and illuminates steadily when the fault sound is silenced or the CIE enters safe state.
- ✧ **DISABLE:** Yellow. It illuminates steadily if any zone, sounder output or alarm routing output is disabled.
- ✧ **SUPERVISED:** Yellow. It flashes when any zone defined as supervisory is activated. It illuminates steadily when the supervisory sound is silenced.
- ✧ **IN TEST:** Yellow. It illuminates steadily when any zone is in test condition.
- ✧ **MAINS FAULT:** Yellow. It flashes when there is mains fault and illuminates steadily when the fault sound is silenced.

- ✧ **BATTERY FAULT:** Yellow. It flashes when there is battery fault and illuminates steadily when the fault sound is silenced.
- ✧ **CHARGER FAULT:** Yellow. It flashes when there is charger fault and illuminates steadily after the fault sound is silenced.
- ✧ **EARTH FAULT:** Yellow. It flashes when any cable of sounder output (voltage contact), alarm routing output, auxiliary power output or zone input, connects with the enclosure of the panel. It illuminates steadily when the fault sound is silenced.
- ✧ **SYSTEM FAULT:** Yellow. It illuminates steadily when the CPU is in fault condition or CPU communication is abnormal.
- ✧ **DELAY MODE:** Yellow. It flashes when there is an alarm output or sounder output in delayed condition.
- ✧ **BUZZER MUTE:** Yellow. It illuminates steadily when the buzzer is silenced.
- ✧ **SILENCE:** Yellow. It illuminates steadily when the sounders are silenced.
- ✧ **SOUNDER 1 FLT/DIS:** Yellow. It flashes when Sounder 1 output is in fault condition, and it illuminates steadily when Sounder 1 output is disabled.
- ✧ **SOUNDER 2 FLT/DIS:** Yellow. It flashes when Sounder 2 output is in fault condition, and it illuminates steadily when Sounder 2 output is disabled.
- ✧ **SOUNDER 3 FLT/DIS:** Yellow. It flashes when Sounder 3 output is in fault condition, and it illuminates steadily when Sounder 3 output is disabled.
- ✧ **ALARM OUTPUT FAULT:** Yellow. It flashes when alarm output is in fault condition, and it illuminates steadily when Alarm output is disabled.

1.3.2 Zone Status Indicators

- ✧ **ZONE RED LED:** Red. It flashes when a zone is in fire condition (0.5: 0.5) . And it illuminates steadily after Mute/ACK is pressed.
- ✧ **ZONE AMBER LED:** Yellow. It flashes when the zone is in fault condition (0.5: 0.5) . And it illuminates steadily when the zone is disabled or in test mode.
- ✧ **ZONE SUPERVISED LED (Z1~Z16) :** *It illuminates GREEN when the zone is defined as a supervisory type. (Factory Default, refer to Chapter 3.6.2 for programming instructions). This feature is typically used for pump running and pump stopped indications.*

1.3.3 Operating Indicators and Keys

- ✧ Keys
 - **SILENCE BUZZER:** In Access Level I and access level II, fault sound, supervisory sound, and an alarm sound can be silenced.
 - **SILENCE/RESOUND ALARM:** Pressing this key can silence all the sounders outputs; pressing it again in fire condition, the silenced sounders output will be activated again. The LED illuminates yellow steadily when the sounders are silenced.
 - **RESET:** It is available in Access Level II for resetting the control panel.
 - **DISABLE:** It is available in Access Level II. Pressing this key can disable all zones with a fire condition. Note: The warning system must first be silenced in order for this button to operate.
 - **DIS/ENABLE WARNING SYSTEM:** It is available in Access Level II. Pressing this key can disable/enable all sounder outputs.
 - **SCROLL:** It is available in Access Level II for scrolling to choose.
 - **CANCEL:** It is available in Access Level II for cancellation.

- **ENTER:** It is available in Access Level II for confirmation.
- ✧ Keys with LEDs
 - **EVAC:** It is available in Access Level II. Pressing this key can start all sounders for evacuation and the LED illuminates yellow steadily. Press key again to cancel.
 - **DISABLE/ENABLE:** It is available in Access Level II. Pressing this key can disable or enable an output or a zone and the LED illuminates yellow steadily.
 - **OUTPUT PROGRAM:** It is available in Access Level III. Pressing this key can set output program and the LED illuminates yellow steadily.
 - **TEST:** It is available in Access Level II. Pressing this key can set test status and the LED illuminates yellow steadily.
- ✧ Control Lock
 - **CONTROL ENABLE:** If it's switched to the "OFF" position, the CIE is at the access level 1. If it's switched to the "ON" position, the CIE is at the access level 2. The 003 key is not removable in access level 2

1.4 Configuration and Functions

1.4.1 Internal Components

The internal construction of the CIE cabinets is shown in Fig. 1-2.

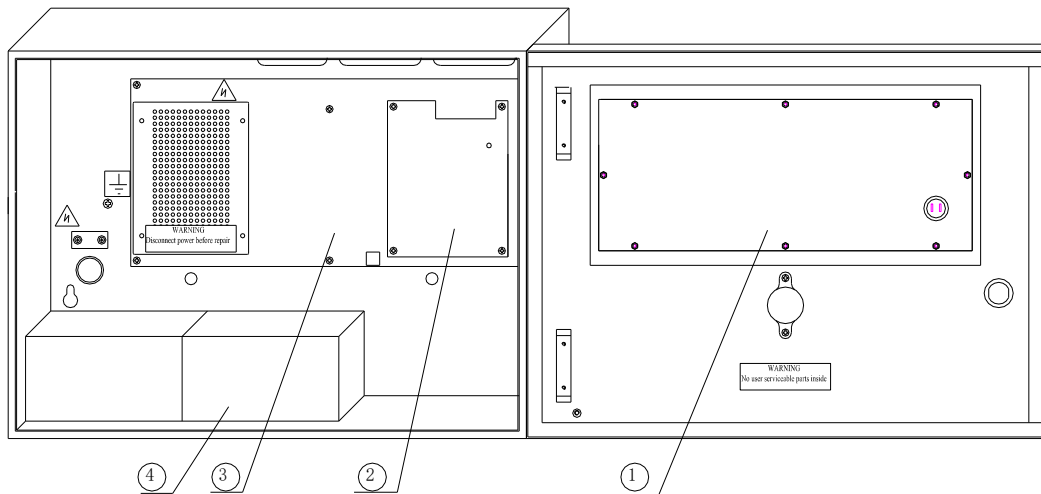

Fig. 1-2

- ① Display board ② Optional relay board or zone extension board for 16 zone panel
- ③ Control board ④ Batteries

1.4.2 Configuration and Functions of GST-116A .

GST-116A control panels have the following configuration and functions.

- ✧ Batteries: Standby power source for the CIE.
- ✧ Control board: For controlling power supply, charger, and all outputs such as fault/disable/supervisory relay output, alarm output, sounder outputs and repeater panel for zone 1 to 8, and monitoring the state of zone 1 to 8.
- ✧ Extension board: Providing detection input and repeater output for zone 9 to 16.

- ◇ Display board: For information display and key operation.
- ◇ Relay board (optional): Providing detection input and repeater output for zone 9 to 16. Controlling outputs of alarm relay and fault relay for zone 1 to 16.

1.4.3 Configuration and Functions of GST-108A

GST-108A control panels have the following configuration and functions.

- ◇ Batteries: Standby power source for the CIE.
- ◇ Control board: For controlling power supply, charger, and all outputs such as fault/disable/supervisory relay output, alarm output, sounder outputs and repeater panel for zone 1 to 8, and monitoring the state of zone 1 to 8.
- ◇ Display board: For information display and key operation.
- ◇ Relay board (optional): Controlling outputs of alarm relay and fault relay for zone 1 to 8.

1.4.4 Configuration and Functions of GST-104A.

GST-104A control panels have the following configuration and functions.

- ◇ Batteries: Standby power source for the CIE.
- ◇ Control board: For controlling power supply, charger, and all outputs such as fault/disable/supervisory relay output, alarm output, sounder output and repeater panel for zone 1 to 4, and monitoring the state of zone 1 to 4.
- ◇ Display board: For information display and key operation.
- ◇ Relay board (optional): Controlling outputs of alarm relay and fault relay for zone 1 to 4.

1.4.5 Configuration and Functions of GST-102A

GST-102A control panels have the following configuration and functions.

- ◇ Batteries: Standby power source for the CIE.
- ◇ Control board: For controlling power supply, charger, and all outputs such as fault/disable/supervisory relay output, alarm output, sounder outputs and repeater panel for zone 1 to 2, and monitoring the state of zone 1 to 2.
- ◇ Display board: For information display and key operation.
- ◇ Relay board (optional): Controlling outputs of alarm relay and fault relay for zone 1 to 2.

1.5 Terminal Description

1.5.1 Terminals on the Control Board

Note: *The contents of italics are not covered in EN54-2/4.*

Terminals for batteries are shown in Fig. 1-3.

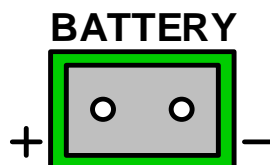

Fig. 1-3

- ◇ **BATTERY (+, -):** Battery input terminals.

Other terminals on the control board are shown in Fig. 1-4.

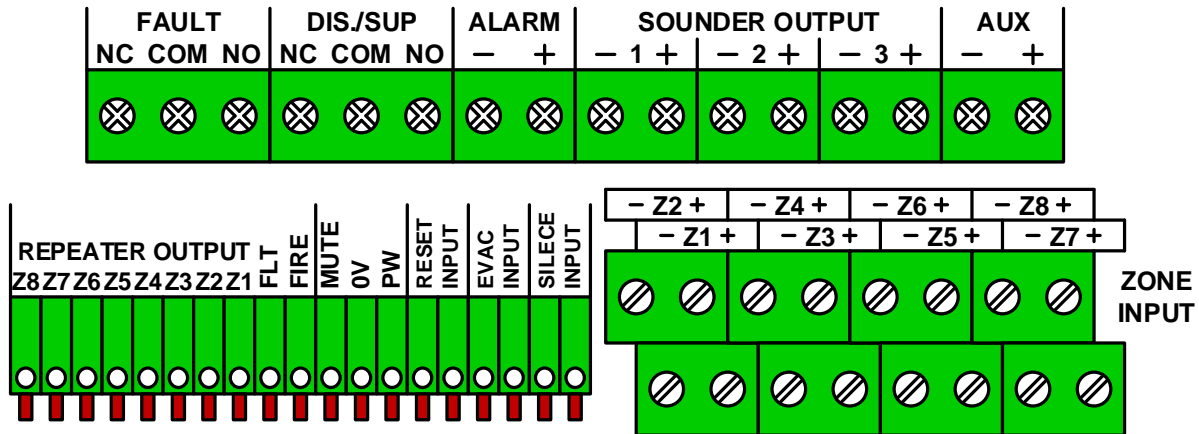

Fig. 1-4

- ◇ **FAULT (NC, COM, NO):** Fault output terminal.
- ◇ **DIS. / SUP. (NC, COM, NO):** Disable/supervisory terminal.
- ◇ **ALARM OUTPUT (-, +):** Alarm output terminal.
- ◇ **SOUNDER OUTPUT (1~3) (-, +):** Sounder output terminals.
- ◇ **AUX SUPPLY (-, +):** Auxiliary power terminal.
- ◇ **REPEATER OUTPUT (Z1~Z8):** Output terminals of repeater panel for zone 1 to 8.
- ◇ **FLT:** Fault terminal for repeater panel connection.
- ◇ **FIRE:** Fire alarm terminal for repeater panel connection.
- ◇ **MUTE:** Mute terminal for repeater panel connection.
- ◇ **0V:** Power supply negative terminal for repeater panel connection.
- ◇ **PW ON:** Reserve terminal for repeater panel connection.
- ◇ **RESET INPUT:** For remote operation of reset.
- ◇ **EVAC INPUT:** For remote operation of EVAC.
- ◇ **SILENCE INPUT:** For remote operation of silence.
- ◇ **ZONE INPUT (1~8):** Zone 1 to 8 input terminals.

1.5.2 Terminals on Extension Board

Note: *The contents of italics are not covered in EN54-2/4.*

Terminals on the extension board are shown in Fig. 1-5 and Fig. 1-6.

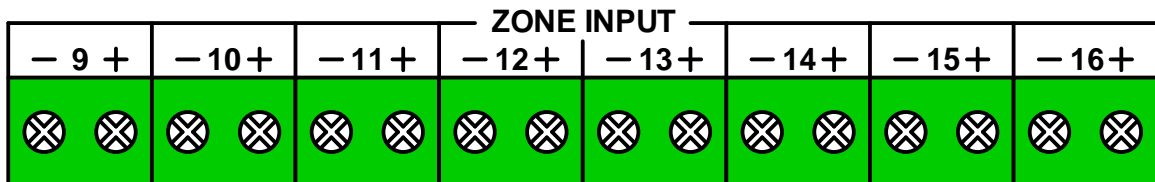

Fig. 1-5

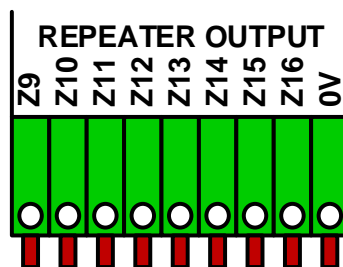

Fig. 1-6

- ✧ **ZONE INPUT (9~16):** Zone 9 to 16 input terminals.
- ✧ **Z9~Z16:** Output terminals of repeater panel for zone 9 to 16.
- ✧ **0V:** Power supply negative terminal for repeater panel connection.

1.5.3 Terminals on Relay Board of RB116A

Note: *The contents of italics are not covered in EN54-2/4.*

Terminals on relay board of RB116 are shown in Fig. 1-7 and Fig. 1-8.

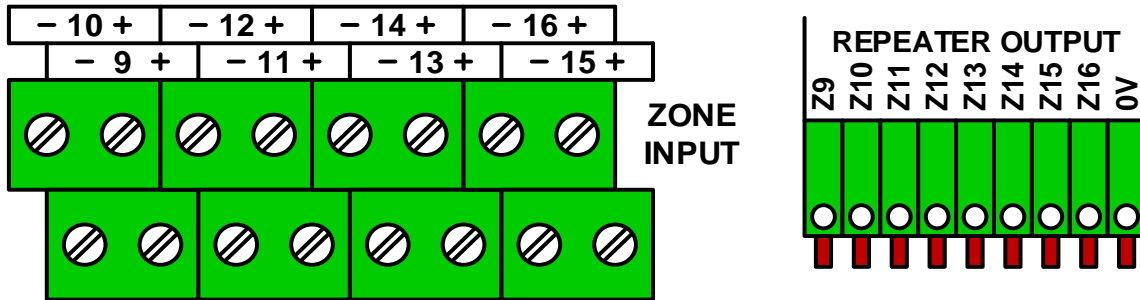

Fig. 1-7

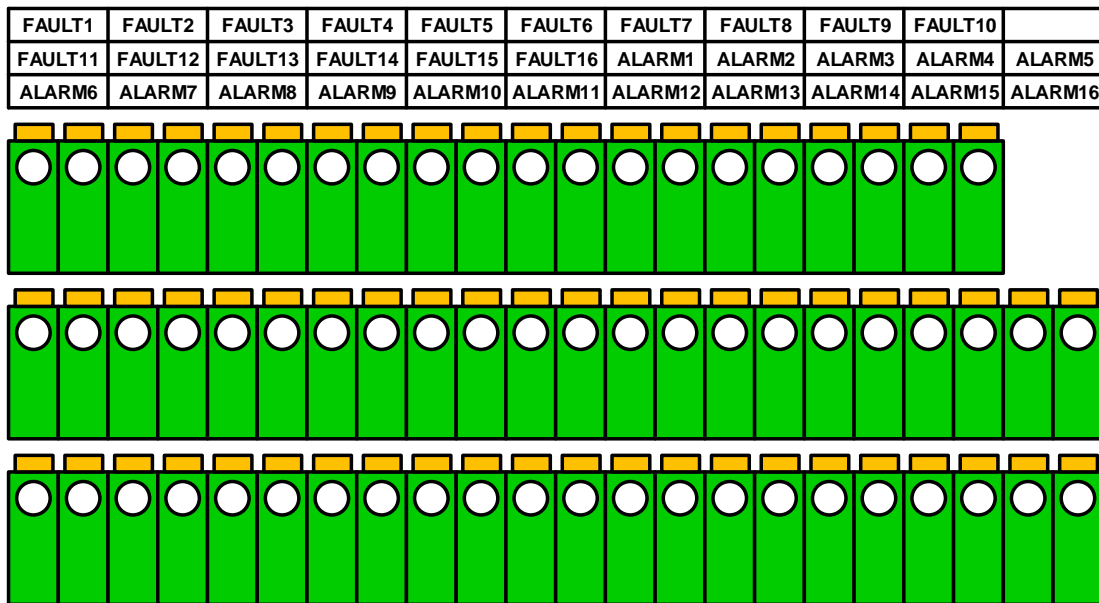

Fig. 1-8

- ✧ **ZONE INPUT 9~16:** Zone 9 to 16 input terminals.
- ✧ **Z9~Z16:** Output terminals of repeater panel for zone 9 to 16.
- ✧ **0V:** Power supply negative terminal for repeater panel connection.
- ✧ **FAULT1~FAULT16:** Fault output terminals for zone 1 to 16.
- ✧ **ALARM1~ALARM16:** Alarm output terminals for zone 1 to 16.

1.5.4 Terminals on Relay Board of RB108A

Terminals on relay board of RB108A are shown in Fig. 1-9. Relay board of RB104A/RB102A is similar to RB108A with fewer terminals.

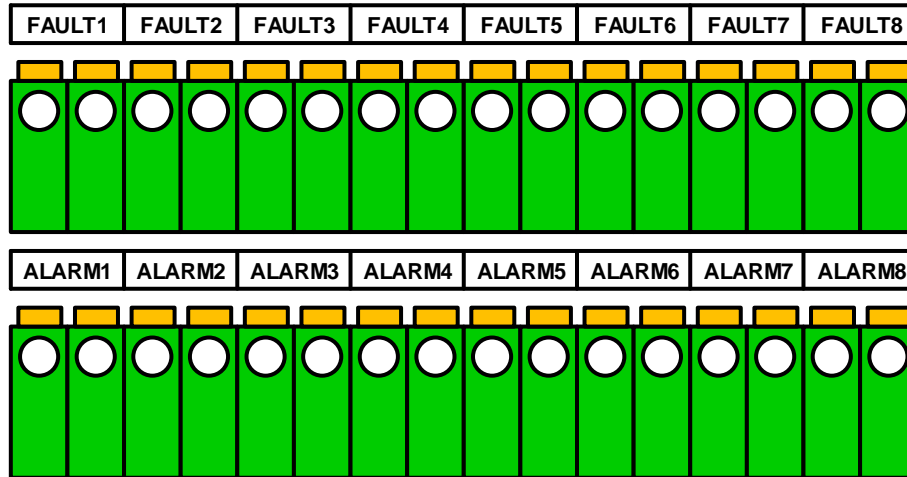

Fig. 1-9

- ◇ **FAULT1~FAULT8:** Fault output terminals for zone 1 to 8.
- ◇ **ALARM1~ALARM8:** Alarm output terminals for zone 1 to 8.

Chapter 2 Installation and Wiring

2.1 Installing the Cabinet

The FACP is wall-mounted as in Fig 2-1A.

Note: Cable connector should be installed in the knock-out hole to avoid cable abrasion and foreign objects.

The below diagrams show the mounting holes for both the small version cabinets (Fig 2-1B).

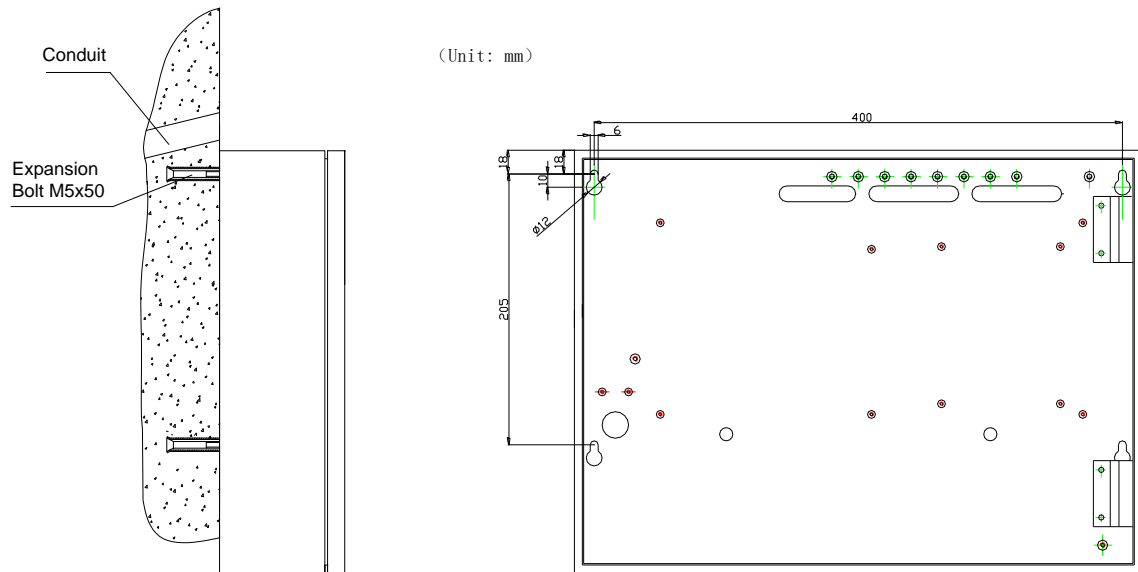

Fig. 2-1A

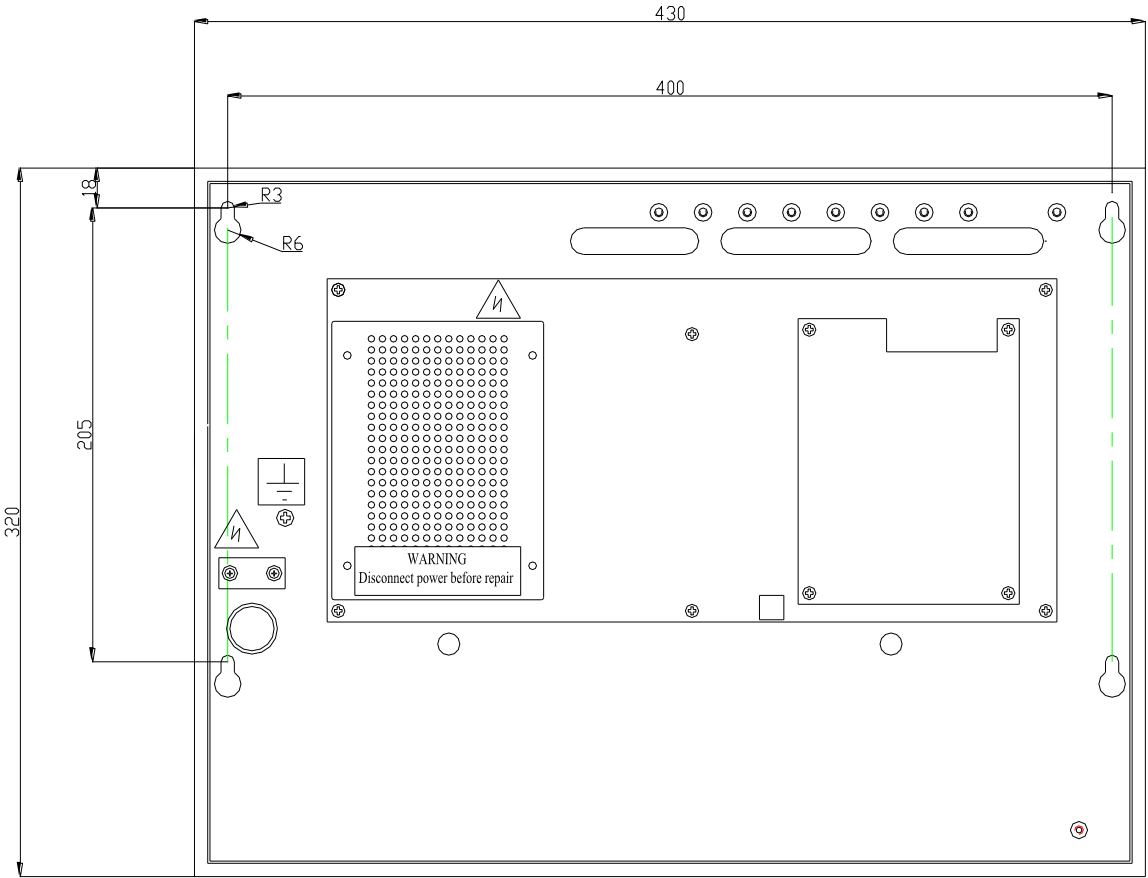

Fig. 2-1B

2.2 Mains Connection

The CIE is powered by 220/230VAC. It's recommended to use 1.5mm² or above shield cable, subject to local installation codes.

The incoming power cable ground (Green/Yellow) wire should be connected to terminal G and be reliably grounded. Connect the neutral (Blue) wire to terminal N and connect the Live (Brown) wire to terminal L. See the Fig. 2.2.

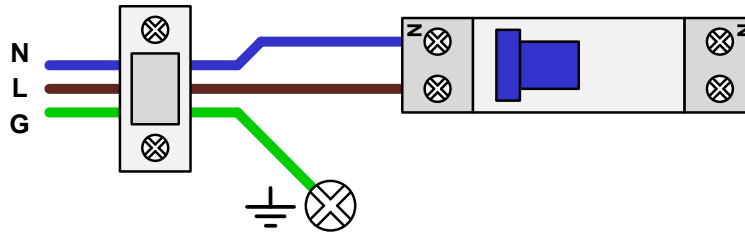

Fig. 2-2

Note:

- The power cables shall be fixed to the enclosure using a restraint clamp for strain relief.
- Do not power the system until the installation is completed.

2.3 Battery Connection

Connect the batteries as in Fig. 2-3 and then to the battery terminal XT2 on the control board.

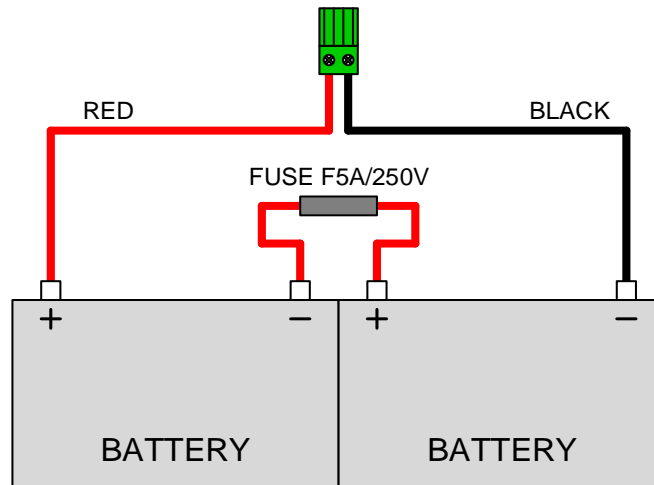

Fig. 2-3

☆☆

Note:

- Refer to Chapter 5 for Calculation of Batteries.
- Do not make battery connections until the installation is completed.
- The fuse of the batteries may be broken if the polarity is connected incorrectly.

☆☆

2.4 Zone Input Connection

Each zone can have maximum 32 fire detectors. The total number of detectors and call points in a zone should not exceed 32. They can be connected in two ways.

2.4.1 Using end of line resistor

Connect all manual call points in front of the detectors and put a 4.7kΩ resistor at the end of the loop, as shown in Fig. 2-4.

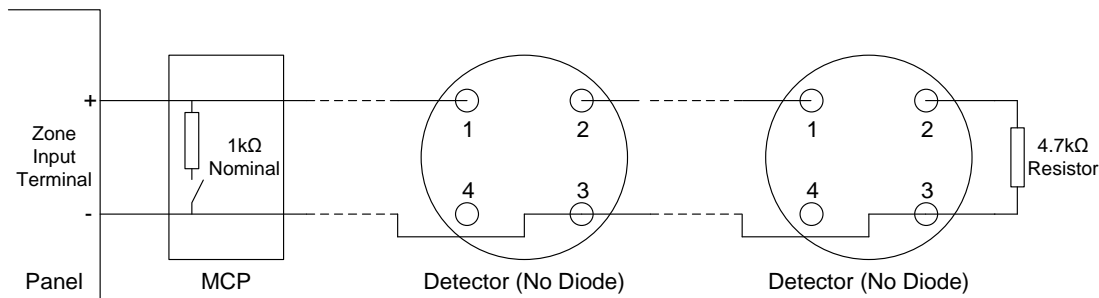

Fig. 2-4

2.4.2 Using an Active End of Line Unit

If an active end of line unit (AEOL) is used at the end of the loop, then the detectors and manual call points can be connected at any position. Ensure the detector base is fitted with a diode to keep the cable continuity in case any detector is removed, as shown in Fig. 2-5.

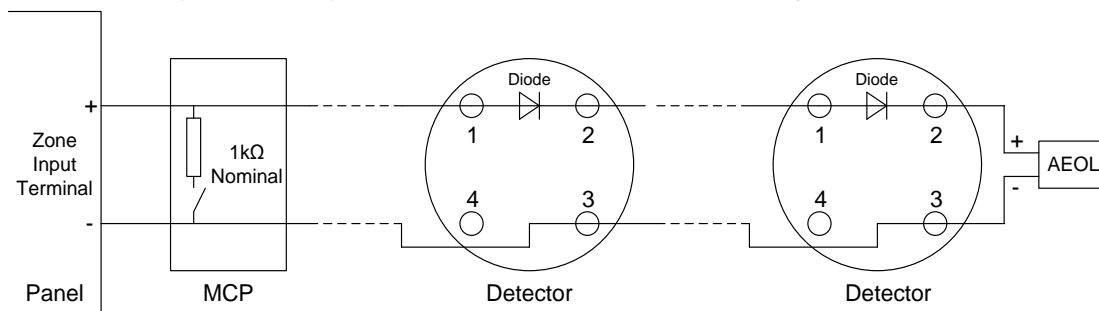

Fig. 2-5

2.5 Sounder/Fire Alarm Output Connections

All 24VDC sounders or remote devices are polarity-sensitive and need to be connected with the correct polarity. A 4.7kΩ resistor shall be connected in parallel at the end of the wiring circuit. Fig. 2-6 shows the connection of Sounder Output.

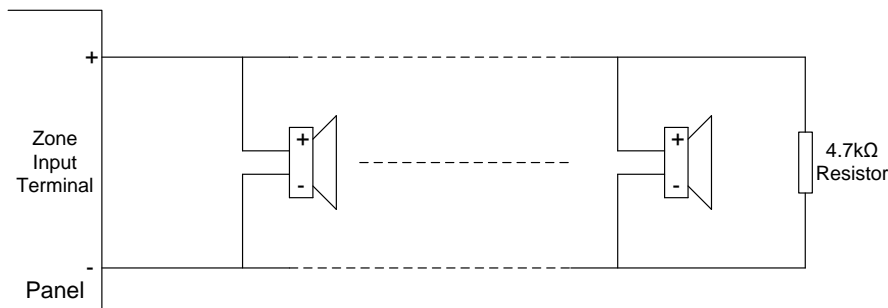

Fig. 2-6

Chapter 3 System Setup

3.1 Setting Access Levels

The CIE provides three access levels:

- ✧ Level I, for anybody to silence the buzzer by pressing *Mute/ACK* key.
- ✧ Level II, for a fire warden or fire brigade personnel to disable, test, reset the panel, silence the buzzer, silence/resound the sounder outputs, evacuate the building and so on.
- ✧ Level III, Used by fire service maintenance companies for the programming of various output modes.

3.1.1 Setting Access Level I

Turning CONTROL ENABLE lock to “OFF” shown as in Fig. 3-1, the CIE is set to access level I. Please be aware dip switch number 1 of SW2 (*LEVEL 3 Access Mode*) on the control board should also be in the OFF position as shown in Fig. 3-3.

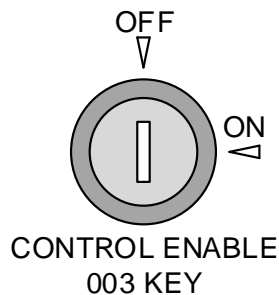

Fig. 3-1

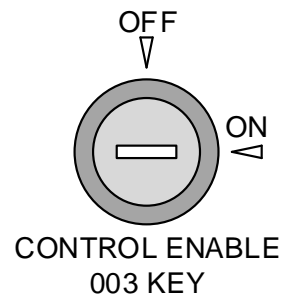

Fig. 3-2

3.1.2 Setting Access Level II

Turning CONTROL ENABLE lock to “ON” shown as in Fig. 3-2, the CIE is set to access level II. Please be aware dip switch number 1 of SW2 (*LEVEL 3 Access Mode*) on the control board should also be in the OFF position as shown in Fig. 3-3.

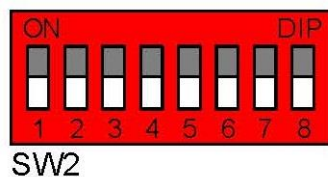

Fig. 3-3

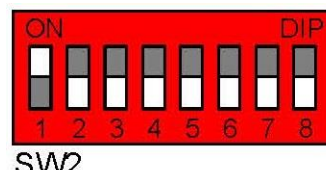

Fig. 3-4

(White cell indicates the position of switch)

3.1.3 Setting Access Level III

If “1” of SW2 (*LEVEL 3*) is set to ON position as shown in Fig. 3-4, whichever position the Control Enable lock is, the CIE is set to access level III.







3.2 Setup of the Sounder / Alarm Output

Sounder Output 1 and alarm output can be set through Pins for three output modes: voltage output, normally open contact output and normally closed contact output. The default setting for alarm output is a normally open contact output. The default setting for Sounder Output 1 is a 24VDC voltage output.

Sounder Outputs 2 and 3 only have 24VDC voltage output modes.

Alarm Output (X1) and Sounder Output 1 (X2) are set as shown in Table 3-5.

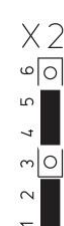
Table 3-5

	Output	Normally closed contact	Normally open contact	Voltage output
DO NOT CHANGE JUMPER SETTINGS WITH POWER STILL CONNECTED	Alarm output:	Link pins 1 & 2, and 3 & 4 of X1 as shown 	Link pins 1 & 2, and 4 & 5 of X1 as shown (<i>Default</i>) 	Link pins 2 & 3 and 5 & 6 of X1 as shown 
	Sounder output 1:	Link pins 1 & 2, and 3 & 4 of X2 as shown 	Link pins 1 & 2, and 4 & 5 of X2 as shown 	Link pins 2 & 3 and 5 & 6 of X2 as shown (<i>Default</i>) 

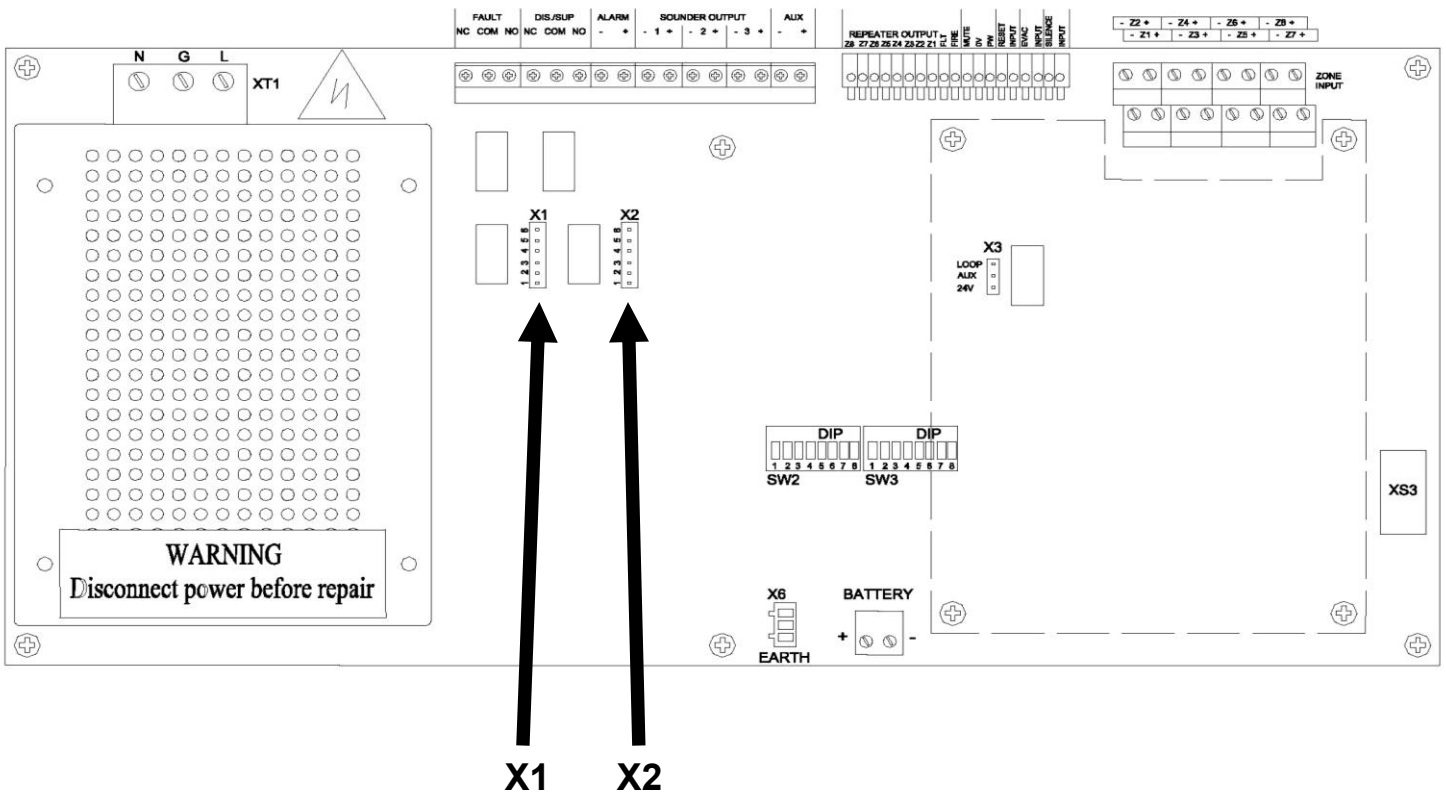

Fig. 5

3.3 Disablement of a Zone or Output

3.3.1 Use of Disablement Function

In case there is any fault with a detection zone or a sounder/alarm output, it can be disabled so that it does not affect normal operation of other zones. After the fault is removed, the disabled detection zone or output can be enabled again. This operation applies to the 16 detection zones, 3 sounder outputs, and 1 fire alarm output.



The following steps show how to operate the *DISABLE* button.

1. Enter access level II as described in Section 3.1.2.
2. First, pressing the **SILENCE/RESOUND ALARM** button silences the sounder output when any zone is in fire condition.
3. Pressing the **DISABLE** button, *DISABLE* LED illuminates steadily and the amber LEDs of all zones in fire condition illuminate.
4. Exit access level II.

The following steps show how to operate the **DIS/ENABLE WARNING SYSTEM** button.

1. Enter access level II.
2. Pressing the **DIS/ENABLE WARNING SYSTEM** button, *DISABLE* LED and *SOUNDER X FLT/DIS* LED illuminate steadily and all sounder outputs are disabled. The CIE will give 1s sound indication.
3. Pressing the **DIS/ENABLE WARNING SYSTEM** key again, *SOUNDER X FLT/DIS* LED turns off. *DISABLE* LED also turns off if there is no other disablement event. The CIE will give 1 second sound indication.
4. Exit access level II.

3.4 Setting Test Mode

3.4.1 Use of Test Mode

Test mode is for testing that the detection zones operate correctly. In this mode, it tests if a zone can generate a fire alarm signal when it's manually activated into fire condition, Alarm Output will not be activated, and sounder outputs can be programmed to either output for 10 seconds or no output (refer section 3.7 for details).

☆☆

Note: Test mode cannot be saved even if the CIE is powered off.

Note: The reset operation can restore the fire in test mode.

☆☆

3.4.2 Operation Steps

1. Enter access Level II.
2. Pressing the **TEST** button, *TEST* LED illuminates steadily. The amber LED of zone 1 starts flashing, showing the CIE is in test mode and that zone 1 is selected. The *FAULT* LED will indicate according to the CIE fault condition. Other indicators, except for the above mentioned LEDs, will be turned off.
3. Pressing the **SCROLL** button will toggle between zones 1 to 16.
4. Zone amber LED for zone 1 to 16 will flash when the zone is to be selected. Pressing the **ENTER** button to set the zone to test mode. The illuminating *IN TEST* LED indicates the zone is in test mode.
5. Pressing the **ENTER** button can change the zone is defined as test zone or not and the CIE will give 1 second sound indication.
6. Pressing the **CANCEL** button exits test mode setting status and *TEST* LED turns off.
7. Exit access Level II.

3.4.3 Test zone output mode

TEST ZONE OUTPUT MODE: When the “5” of SW3 (TEST ZONE OUT) is set to the ON position, test zone output mode is turned on. When a zone is in test mode and there is an alarm signal, coming from the zone, the sounder outputs associated to the zone will be automatically activated for 5 seconds. If test zone output mode is turned off, the sounder outputs will not be activated. Default setting is OFF.

3.5 Programming Output Modes

All output settings programming has to be done under Access Level III. So before programming the Outputs, please first enter Access Level III according to the instructions in Section 3.1.3.

The CIE can be programmed through keypad for the functions below:

- ✧ Setting a zone “With Manual Call Point”. If a zone is set “With Manual Call Point”, a fire alarm from the zone will activate its associated sounder outputs and alarm output, regardless of whether the zone is set with delayed output or not;
- ✧ Associating a zone with sounder outputs. The output mode, sound pattern, and delay time of the sounders associated to the zone can be set respectively.
- ✧ Setting delay time for alarm output.

3.5.1 Setting Zone “With Manual Call Point”

If a zone is set “With Manual Call Point”, any fire alarm coming from that zone (either from a detector or a manual call point), the CIE will immediately alarm and activate all sounders associated to that zone and the alarm output regardless of any delay setting. Basic steps are shown below.

- 1 Enter access level III.
- 2 Set the “2” of SW2 (*MCP ZONE*) on control board to ON position.
- 3 Pressing the **OUTPUT PROGRAM** button, the *OUTPUT PROGRAM* LED illuminates steadily and the amber LED of zone 1 flashes to show zone 1 is to be selected for “With Manual Call Point” setup. And DELAY MODE led flashes. The *FAULT* LED will indicate according to the CIE fault condition. Other indicators, except for the above mentioned LEDs, will be turned off.
- 4 Pressing the **SCROLL** button toggles between zones 1 to 16.
- 5 The amber LED for zone 1 to 16 will flash when the zone is selected. Pressing the **ENTER** button can choose whether or not to program the zone as “With Manual Call Point” and the CIE will give 1 second sound indication. The amber zone LED illuminates steadily to indicate the zone is NOT programmed as “With Manual Call Point”.
- 6 Pressing the **CANCEL** button exits the programming mode and the *OUTPUT PROGRAM* LED will be turned off.
- 7 Set the “2” of SW2 (*MCP ZONE*) to OFF position.
- 8 Exit access level III.

☆☆

Note: If one of the outputs (sounder outputs or alarm output) is programmed with delay, then there should be at least one zone set as “With Manual Call Point” to ensure the delay could be overrode for immediate output.

Note: The zone “with manual call point” can override all delay functions.

Note: Every zone is default set “With Manual Call Point”.

☆☆

3.5.2 Setting Associated Sounders to a Zone

Programming steps of zone association output setting are shown below.

- 1 Enter access level III.
- 2 Set the “4” of SW2 (*SOUNDER OUTPUT*) on control board to ON position.
- 3 Pressing the **OUTPUT PROGRAM** button, *OUTPUT PROGRAM* LED illuminates steadily and the amber LED of zone 1 flashes to show zone 1 is to be selected for setting up associated sounders. The *FAULT* LED will indicate according to the CIE fault condition. Other indicators, except for the above mentioned LEDs, will be turned off.
- 4 Pressing the **SCROLL** button toggles between zones 1 to 16.
- 5 Press the **OUTPUT PROGRAM** button again to set up its associated Sounder Outputs. The *SOUNDER X FLT/DIS* LED flashes, showing Sounder Output 1 has been selected for setup.
- 6 Pressing the **SCROLL** button to select sounder output 1, 2 or 3.
- 7 Pressing the **DISABLE/ENABLE** or **TEST** button can respectively switch on or off their indicator. The *DISABLE/ENABLE* LED and *TEST* LED are used for setting up the output state of the selected Sounder Output to be an Immediate, Delayed or No Output, refer Chapter 3-5-4, Table 3-6.
- 8 **Set the “5” of SW2 (*SOUNDER MODE*) ON or OFF** to change the sound pattern of the selected Sounder Output to be continuous or pulse, refer Chapter 3-5-4, Table 3-7.
- 9 The Dip switches “1” to “4” of SW3 (*DELAY TIME*) are used for setting the delay time of the selected Sounder Output from 0-150 seconds, refer Chapter 3-5-4, Table 3-8.
- 10 Pressing the **ENTER** button saves the current settings for *SOUNDER X* and the CIE will sound for 1 second to indicate the successful setup. **Set the “5” of SW2 (*SOUNDER MODE*) and “1” to “4” of SW3 (*DELAY TIME*) to OFF position.** Repeat steps 6 to 10 to program another Sounder Output for this zone.
- 11 Press the **CANCEL** button to exit the programming of this zone and return to the zone selection (step 4). Repeat steps 4 to 10 to program other zones.
- 12 At the zone selection step, pressing the **CANCEL** button again will exit programming mode. *And OUTPUT PROGRAM* LED will turn off.
- 13 Set the “4” of SW2 (*SOUNDER OUTPUT*) to OFF position.
- 14 Exit access level III.









Two sounder patterns are shown in Table 3-7. Default setting is Continuous Output

Table 3-7

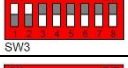
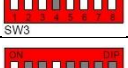
Sounder Patterns	"5" of SW3 (<i>SOUNDER MODE</i>)
Pulse Output	ON
Continuous Output	OFF (Default)

Delay time can be obtained as shown in Table 3-8. Default setting is 0 seconds

Table 3-8

Delay (s)	"1" to "4" of SW3 (<i>DELAY TIME</i>)					 SW3
	1	2	3	4		
0	OFF	OFF	OFF	OFF		 SW3
10	ON	OFF	OFF	OFF		 SW3
20	OFF	ON	OFF	OFF		 SW3
30	ON	ON	OFF	OFF		 SW3
40	OFF	OFF	ON	OFF		 SW3
50	ON	OFF	ON	OFF		 SW3
60	OFF	ON	ON	OFF		 SW3
70	ON	ON	ON	OFF		 SW3
80	OFF	OFF	OFF	ON		 SW3
90	ON	OFF	OFF	ON		 SW3
100	OFF	ON	OFF	ON		 SW3
110	ON	ON	OFF	ON		 SW3
120	OFF	OFF	ON	ON		 SW3
130	ON	OFF	ON	ON		 SW3
140	OFF	ON	ON	ON		 SW3
150	ON	ON	ON	ON		 SW3



3.7 Setting Auxiliary Functions

- ✧ RESOUND MODE: When the “6” of SW2 (*RESOUND MODE*) is set to the ON position, resound mode is turned on. When there is fire alarm from a zone, the sounder outputs associated to this zone will be started. Pressing *SILENCE/RESOUND ALARM* key and these sounder outputs can be silenced; if there is an alarm signal from another zone at this moment, the silenced sounder outputs that are not associated to this new alarm zone will resound. If resound mode is turned off, the silenced sounder outputs not associated to this new alarm zone will remain silenced. Default setting is ON.
- ✧ SILENCE RESET MODE: When the “7” of SW2 (*SIL-RESET MODE*) is set to the ON position, silence-reset mode is turned on. When there is fire alarm from a zone and its associated sounder outputs are started, the CIE will not be reset until the sounder outputs are silenced. If silence-reset mode is turned off, the CIE can be reset immediately. Default setting is ON.
- ✧ SILENCE DELAY MODE: When the “8” of SW2 (*SIL-DEALY MODE*) is set to the ON position, silence-delay mode is turned on. When there is fire alarm from a zone and its associated sounder outputs are started, the CIE has to stay in fire condition for 3 minutes before the sounder outputs could be silenced. If silence-delay mode is turned off, the sounder outputs can be silenced immediately. Default setting is OFF.
- ✧ DISABLE/SUPERVISED OUTPUT MODE: When the “6” of SW3 (*DIS. / SUP. OUT*) is set to the OFF position, the disable/supervised relay output is set for disable output; otherwise, this output is set for supervised output. Default setting is OFF.
- ✧ RELAY OUTPUT MODE: When the “7” of SW3 (*RELAY OUTPUT*) is set to the OFF position, the FAULT1 to FAULT16 on relay board are defaulted as fault outputs. When the “7” of SW3 (*RELAY OUTPUT*) of is set to the ON position, FAULT1 to FAULT16 on relay board are set to general fire trips, which all will activate on any zone fire alarm. Default setting is OFF.

☆☆

Note: The auxiliary function has not been tested in EN54-2/4.

☆☆

3.8 Ground Fault Detection

The CIE can detect a ground fault by connecting the X6(*EARTH FAULT*) with a jumper. Otherwise, the CIE does not detect a ground fault.

3.9 Auxiliary Power Setting

Shorting “24V” and “AUX” of X3 with a jumper, the *AUX SUPPLY* output will be constant. If shorting “AUX” and “LOOP” of X3, the *AUX SUPPLY* output will drop for about 10 seconds when the CIE is reset.

3.10 Restore Default Settings

The basic features of the default settings are as follows:

- ✧ Every zone is set “With Manual Call Point”.
- ✧ When there is fire alarm from any zone, all sounder outputs will be started, and these outputs will be continuous and not be delayed.
- ✧ The alarm output is not set with delay time.
- ✧ All zones and sounder outputs are not disabled.

A quick way to restore default settings as follows:

- 1 Enter access level III.
- 2 Pressing the **OUTPUT PROGRAM** button for at least 2 seconds, the CIE gives 1 second sound indication to indicate a successful reset to factory settings.
- 3 Exit access level III.

3.11 Default DIP Switch Settings

Label	Location	Setting
Alarm output	X1	N/O
Sounder 1 Output	X2	Voltage
Aux Power	X3	Jumper pins on AUX + 24 for continuous voltage
Ground Fault	X6	connected
Level 3	SW2	1 off
MCP zone		2 off
Alarm output		3 off
sounder output		4 off
sounder mode		5 off
resound mode		6 off
sil-reset mode		7 off
sil-delay mode		8 off
Delay time 1	SW3	1 off
Delay time 2		2 off
Delay time 3		3 off
Delay time 4		4 off
test zone out		5 off
dis/sup. Out		6 off
Relay output		7 off
reserve use		8 off



Chapter 4 Operation Instructions

4.1 Working State Description

4.1.1 State of Detection Zones

- ✧ Normal: If a zone is in normal condition, the zones' red and amber LEDs are off, only the power LED (green) is on.
- ✧ Fire: If there is a zone in fire condition, *FIRE* LED and zone red LED flash. In access level II, pressing the **SILENCE BUZZER** button, they will illuminate steadily.
- ✧ Supervisory: non-activated supervisory zone green LED illuminates. Activated supervisory zone SUPERVISED LED flash. In access level II, pressing *SILENCE BUZZER* key, *SUPERVISED* LED illuminate steadily. (Default settings)
- ✧ Fault: If there is a zone in fault condition, *FAULT* LED and zone amber LED flash. In access level I, pressing the **SILENCE BUZZER** button, *FAULT* LED illuminates steadily and zone amber LED remains flashing.
- ✧ Disabled: If there is a zone disabled, *DISABLE* LED and zone amber LED illuminate steadily.

4.1.2 Alarm Output State

- ✧ Normal: If alarm output is in normal condition, *ALARM ROUTING ACTIVATED LED* and *ALARM OUTPUT FAULT* LED should be off.
- ✧ Fire: If the alarm output is activated, *ALARM ROUTING ACTIVATED* LED illuminates steadily.
- ✧ Fault: If the alarm output is in fault condition, *FAULT* LED and *ALARM OUTPUT FAULT* LED flash. In access level I, pressing the **SILENCE BUZZER** button, *FAULT* LED illuminates steadily, *ALARM OUTPUT FAULT* LED remains flashing.

4.1.3 Sounder Outputs State

- ✧ Normal: If a sounder output is in normal condition, *SOUNDER X FLT/DIS* LED should be off.
- ✧ Fault: If there is a fault with any of the sounders, *FAULT* LED and *SOUNDER X FLT/DIS* LED flash. In access level I, pressing the **SILENCE BUZZER** button, *FAULT* LED illuminates steadily and *SOUNDER X FLT/DIS* LED remains flashing.
- ✧ Disabled: If any of the three sounder outputs are disabled, *DISABLE* LED and *SOUNDER X FLT/DIS* LED illuminate steadily.

4.1.4 Safe State

When there is a fault with any CPU that makes the CIE unable to work properly or changes system data, the CIE will enter safe state.

- ✧ *FAULT* and *SYSTEM FAULT* LED illuminate.
- ✧ The buzzer sounds continuously.
- ✧ The keypad cannot be operated.
- ✧ The CIE cannot monitor fire.
- ✧ Fault output is activated.
- ✧ Other outputs remain the same before the CIE enters safe state.
- ✧ Other indicators remain the same before the CIE enters safe state.

☆☆

Note: Safe state can only be cleared by re-powering the CIE.

☆☆



4.1.5 Description of the Buzzer

The buzzer of the CIE sounds by priority coming from high to low as follows: safe state, fire, supervisory, fault and normal. The sound patterns of the buzzer are:

- ◇ Safe state, sounds steadily.
- ◇ Fire alarm, 0.5 second on, 0.5 second off.
- ◇ Supervisory, 1 second on, 1 second off.
- ◇ Fault, 2 second on, 2 second off.
- ◇ Normal, no sound.

4.1.6 Others

- ◇ Access levels are downwards applicable. A higher level enables access at levels lower than it.
- ◇ If there is no key pressed for over 3 minutes, the CIE will exit any menu it is in without saving.
- ◇ Remote EVAC input, SILENCE input and RESET input are dry contact input type. If an input is shorted for 2 seconds, the CIE will operate correspondingly regardless of access levels.
- ◇ A Sounder output delay will only work if all of the following conditions are met:
 - The sounder is associated with a zone and is programmed with delay. (refer 3.5.2)
 - Zone has been set as “No Manual Call Point”. (refer 3.5.1)
 - This sounder output is not activated, not in fault or disabled condition.
 - If fire alarm comes from the associated zone, the sounder output will be started with a delay and *DELAY MODE* LED flashes.
- ◇ Sounders and Alarm Output will not be activated if they are disabled or in fault.

☆☆

Note: If a sounder output is activated with delay, and another zone is also associated with this sounder output but is programmed as immediate output, then a fire alarm from this zone will override the delay and activate the sounder output immediately.

If a sounder output is activated with delay, and another zone is also associated with this sounder but is programmed with a delay time shorter than the remaining delay time, then a fire alarm from this zone will override the previous delay and activate the sounder output with the shorter delay time.

☆☆

4.2 Acknowledgement and Silence of Fault

A fault condition can be acknowledged and silenced from access level I.

Pressing the **SILENCE BUZZER** button under a fault condition, the buzzer of the CIE will be silenced and the fault is acknowledged. *FAULT* LED will illuminate steadily.

4.3 Acknowledgement and Silence of Fire Alarm

A fire alarm can be acknowledged and silenced from access level I.

Pressing the **SILENCE BUZZER** button under fire alarm condition, the buzzer of the CIE will be silenced and the fire alarm is acknowledged. *FIRE* LED and zone red LED will illuminate steadily.

4.4 Silencing the Sounder Outputs

The Sounder Outputs can be silenced at access level II.

Pressing the **SILENCE/RESOUND ALARM** button can silence the sounder outputs. In fire condition, pressing the **SILENCE/RESOUND ALARM** button again will make them resound.

If the remote **SILENCE** input contact is shorted for over 2 seconds, the CIE will silence the sounder outputs regardless of the current access level.

4.5 Evacuation

The evacuation can be operated at access level II.

Pressing the **EVAC** button, all sounder outputs will be started immediately. Pressing the **EVAC** button again, all sounder outputs will be stopped.

If the remote **EVAC** input contact is shorted for over 2 seconds, the CIE will activate EVAC function to start all sounder outputs immediately regardless of the current access level.

4.6 Self-test and Reset

Self-test and reset can be carried out at access level II.

The CIE will start self-test on power-up. Pressing the **Reset** button can clear all audio and visual indication and carry out self-test. The self-test can check all indicators and the buzzer. All indicators illuminate and the buzzer sounds. After self-test, the panel returns to normal condition.

If the remote **RESET** input contact is shorted for over 2 seconds, the CIE will start reset and self-test regardless of the current access level.

Chapter 5 Calculation of Batteries Capacity

The formula for calculating batteries capacity is as follows:

$$\text{Batteries Capacity (Ah)} = (I_{Q_{\max}} + I_{Q_{\text{out}}}) \times T_1 + (I_{Q_{\min}} + I_{L_{\max}} + I_{F_{\text{out}}}) \times T_2$$

In which,

$I_{Q_{\max}}$ is the maximum standby current of the FACP in full load, which is 0.12A (calculated based on 16 zones).

$I_{Q_{\text{out}}}$ is the auxiliary output current in standby condition, which is 0.02A

$I_{Q_{\min}}$ is the FACP circuit consumption in fire condition, which is 0.1A.

$I_{L_{\max}}$ is the loop maximum current allowed for 16 detection zones, which is 0.4A.

$I_{F_{\text{out}}}$ is the output current in alarm condition, which is 2A (1.9A for 3 sounder outputs and 1 fire alarm output, and 0.5A for the auxiliary output).

T_1 is the time for the batteries to work in monitoring status which shall be 24 hours by EN 54-4 standard.

T_2 is the time for the batteries to work in alarm status which shall be 30 minutes by EN 54-4 standard.

From the above, we can get the maximum battery capacity is 4.56AH, so that we recommended a 7AH battery to be used for the system. And as the above calculations are based on the 16-zone GST116A, they are also applicable to GST102A, GST104A and GST108A.



Chapter 6 Servicing

The CIE shall be serviced by specially trained technicians. Please disconnect power before servicing.

6.1 Replacing the Batteries

- ◇ Type: Sealed lead-acid battery.
- ◇ Recommend period for replacement: 5 years (25°C)
- ◇ Recommended manufacturer and model: Yuasa NP7-12
- ◇ Disposal of used batteries: Please properly dispose the used batteries according to your local rules and regulations.

☆☆

WARNING:

RISK OF EXPLOSION IF BATTERIES ARE REPLACED BY AN INCORRECT TYPE!

☆☆

6.2 Replacing the Fuses

There are two types of fuses in the CIE, located on the control board and battery cable respectively as shown in Table 6-1.

Table 6-1

Position	Mark	Rated value
Control Board	F1	2A/250VAC, Time delay, High breaking capacity ceramic tube fuse
Battery Cable	5A/250V	5A/250VAC, Fast, Low breaking capacity glass tube fuse

6.2.1 Follow the Steps Below to Replace F1

- 1 Remove the protective cover from the control board, and you will see the fuse F1.
- 2 Remove the fuse cover and replace the fuse.
- 3 After replacement, put back the fuse cover and the protective cover.

6.2.2 Follow the Steps Below to Replace 5A Fuse.

- 1 Unfasten the fuse holder in the battery connection to find 5A fuse.
- 4 Replace the 5A fuse
- 5 Fasten the fuse holder.

☆☆

Note: Please disconnect power before replacing the fuse.

☆☆

6.3 Troubleshooting

No.	Problem	Possible Reason	Resolution
1	No LED lights on power-up	A. Power not connected B. The F1 on control board is blown. C. Power supply doesn't work properly. D. Connection between the control board and display board is loose.	A. Check power connections B. Replace the fuse F1. C. Replace the control board. D. Check and reconnect the cable.
2	Battery fault	A. Loose battery connection. B. 5A fuse is blown. C. The voltage of batteries is low.	A. Check cable connector. B. Replace 5A fuse in battery cable. C. Replace the batteries.
3	Incorrect report on Sounder Output and Alarm Status	A. Pin X1 / X2 on the control board are not set correctly. B. Control board is damaged.	A. Check settings of X1 / X2 (refer 3.2) B. Replace the control board.
4	Settings cannot be saved	CPU D6 on the control board is damaged	Replace the control board.

Compliance information



548p/03



2831-CPR-F4050
GST-0204-01

11



0832-UKCA-CPR-
F0054

21



(Available for product models: GST-102A)



548p/04



2831-CPR-F4051
GST-0204-01

11



0832-UKCA-CPR-
F0055

21



(Available for product models: GST-104A)



548p/05



2831-CPR-F4049
GST-0204-01

11



0832-UKCA-CPR-
F0056

21



(Available for product models: GST-108A)



548p/06



2831-CPR-F4052
GST-0204-01

11



0832-UKCA-CPR-
F0057

21



(Available for product models: GST-116A)

WEEE Information



2012/19/EU (WEEE directive): Products marked with this symbol cannot be disposed of as unsorted municipal waste in the European Union. For proper recycling, return this product to your local supplier upon the purchase of equivalent new equipment, or dispose of it at designated collection points.

For Article33 information, please refer to the following website:
<https://www.gst.com.cn/en/reacharticle33.asp>

Limited Warranty

GST will repair or replace the product to the original purchaser free of charge, if defective in materials or workmanship during the warranty period, subject to the terms below. GST and CRSS are not responsible for defects or problems as a result of conditions or applications including normal wear and tear; catastrophe; fault or negligence of any user or any party other than GST and CRSS; improper installation, application, storage, maintenance, or use of products; other causes external to products; or failure to conform to any applicable recommendations of GST and CRSS. In no event shall GST and CRSS be liable for incidental, indirect, special or any other consequential damages. To the fullest extent permissible by law, the foregoing limited warranty is exclusive and in lieu of all other warranties, whether written, oral, implied or statutory. Subject to applicable law, in no event shall the liability of GST and CRSS exceed the purchase price of the products. NO IMPLIED WARRANTY OF MERCHANTABILITY OR FITNESS FOR PARTICULAR PURPOSE SHALL APPLY. Anybody, including the agents, distributors or employees, is not in the position to amend the contents of this warranty.

Product warnings and disclaimers

THESE PRODUCTS ARE INTENDED FOR SALE TO AND INSTALLATION BY QUALIFIED PROFESSIONALS. CARRIER FIRE & SECURITY BV, CARRIER FIRE & SECURITY AMERICAS CORPORATION AND THEIR AFFILIATE COMPANIES (TOGETHER AND EACH INDIVIDUALLY "CARRIER") CANNOT PROVIDE ANY ASSURANCE THAT ANY PERSON OR ENTITY BUYING ITS PRODUCTS, INCLUDING ANY "AUTHORIZED DEALER" OR "AUTHORIZED RESELLER", IS PROPERLY TRAINED OR EXPERIENCED TO CORRECTLY INSTALL FIRE AND SECURITY RELATED PRODUCTS.

For more information on warranty disclaimers and product safety information, please check <https://firesecurityproducts.com/policy/product-warning/> or scan the following code:





Gulf Security Technology Co., Ltd.

No. 80 Changjiang East Road, ETDZ, Qinhuangdao, Hebei,

P. R. China 066004

Tel: +86 (0) 335 8502434

service.gst@carrier.com

www.gst.com.cn